



Landscape Products' Specifications Guide

Residential and Commercial Applications

Pavers, Retaining Walls, Outdoor Living
& Landscape Accessories







Landscape Products Specifications Guide

Pavers, Slabs and Patio Stones.....	2
Genesis Face-Mix Technology™	4
Introduction to Dimensionally Compatible Pavers.....	6
Installation Guidelines for Interlocking Concrete Pavers	8
Installation Guidelines for Concrete Slabs	10
Care and Maintenance for Interlocking Concrete Pavers & Slabs	12
Paver Application, Palletization & Availability Table	14
Vantage™ and Grand Vantage™ Pavers	16
Discover™ and Grand Discover™ Pavers	18
Elements™ Paving Stones	20
Glow Path Technology™.....	23
Destination® Pavers	26
Essence™ Wood Grain Plank Pavers	27
Grand Milestone® Pavers	28
Influence Pavers®	29
Skylands™ Concrete Deck Pavers	30
Tranquility® Pavers.....	32
Dimetta® Pavers	34
Permeable Concrete Pavers Specs	36
Installation Guidelines for Permeable Concrete Pavers	38
H ₂ O Pro® Pavers Permeable Paving Units.....	40
Rejuvenate™ Permeable Pavers	44
Harmony™ Permeable Pavers.....	46
Renewable™ Pavers Permeable & Sandset.....	48
Retaining Walls, Garden Walls and Seat Walls.....	50
Installation Guidelines for Retaining Wall Systems	52
Care and Maintenance for Garden & Retaining Walls	58
Tribute® Retaining Wall System	60
Integrity™ Retaining Wall System	62
Winston® Retaining Wall System	63
County Block® Retaining Wall System	64
County Cub® Landscape Units	65
Rib Rock™ Landscape Block	66
Related Retaining Wall Products	70
Outdoor Living Products	72
Outdoor Living Product Palletization Table.....	75
Summit Stone® Landscape Units.....	76
Fireplace Kits (Summit Stone®).....	80
Fire Pit Products (Summit Stone®).....	81
Reflection Stone® Masonry Units	82
Landscape Accessories.....	86
Passageways® Step Units.....	88
Landscape Step Units	88
Oversize Landscape Step Units	89
Crest™ Bullnose Pavers	90
Finishing Touches	91
(Column and Seatwall Caps, Burnished Wall Accents, Fire Ring Caps and Alliance Outdoor Lighting)	
Landscape & Masonry Locations	92



Pavers, Slabs & Patio Stones
Specifications



GENESIS

FACE-MIX TECHNOLOGY™

COUNTY MATERIALS CORPORATION

Pure color pigments and fine aggregates are blended on the surface, providing vibrant, rich and long-lasting color.

Fine aggregates and dense concrete mix provide a smooth, refined surface.

Face-mix is integrally bonded to the base, offering exceptional durability and aesthetic design.

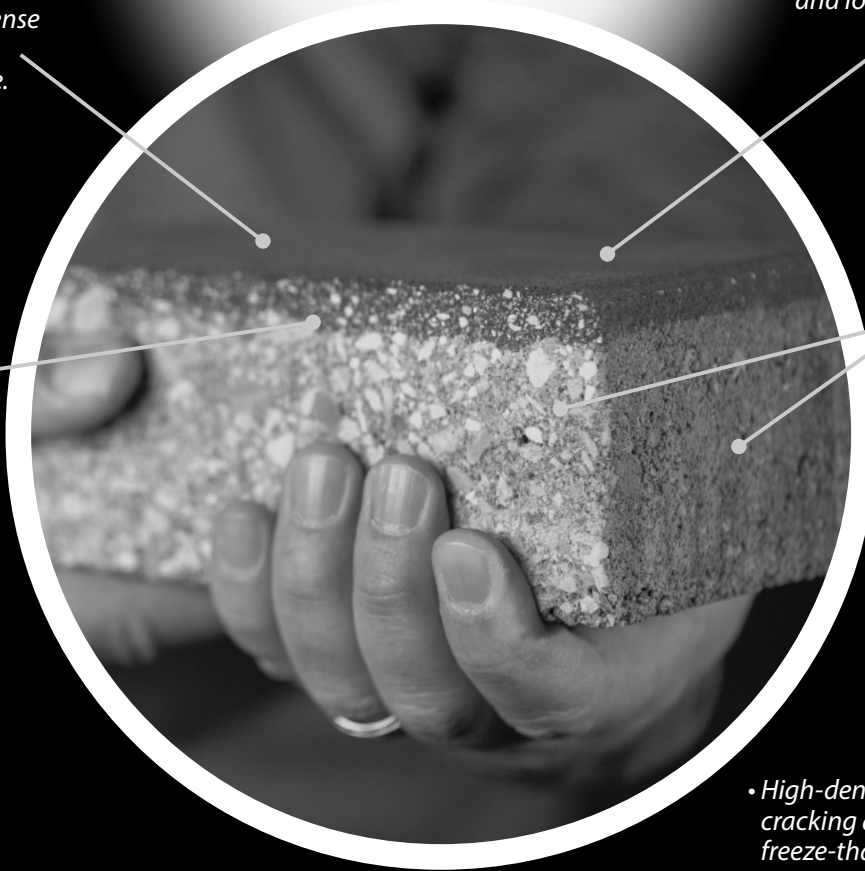

Base concrete mix features larger aggregates for high-compressive strength.

- *High-density units resist cracking and damage from freeze-thaw cycles.*
- *Pavers and slabs are manufactured to meet industry standards for strength and absorption.*
- *County Materials pavers and slabs are backed by our customer warranty.*



Stunning Colors & Amazing Strength

County Materials Corporation utilizes Genesis Face-Mix Technology™ to manufacture beautifully designed pavers and slabs backed by the strength and longevity of quality concrete.

Genesis Face-Mix Technology provides more than surface beauty. Genesis ensures long-lasting color, superior strength and resistance, and unique surface textures. Our pavers and slabs repel stains and withstand everyday wear and tear.

The fine finish of these pavers features a permanent and integrally-blended layer of our high-strength concrete mix.

It's the perfect combination of vibrant color pigments and dense surface materials. Choose **high-quality, long-lasting pavers and slabs without compromising design or aesthetics.**

Each unit is designed to withstand the wear, tear, weathering and abrasion that occurs in a high-traffic area exposed to the elements. We concentrate the purest color pigments, finest aggregates, and densest concrete mix in the top surface layer of each paving stone where it is visible and matters most.

What is the significance of Genesis Face-Mix Technology? It's provenance, a beginning, carving potential into substance. County Materials' landscape products are designed to create a space where fond memories begin. Our team believes in offering quality products that invoke our customers to spend time celebrating with friends and family in their inspiring outdoor living spaces.

County Materials' commitment to quality derives from our talented team

of people who believe in delivering unparalleled craftsmanship, attention to detail, and customer service.

Our Genesis Face-Mix Technology produces high strength pavers and slabs with non-fading colors and **natural beauty that stands the tests of time.** County Materials' concrete pavers are inherently strong, and our Genesis Face-Mix Technology adds extra surface superiority to ensure customer satisfaction for years to come.



County Materials Crafts Paver Lines to Offer Boundless Design Options and Ready Availability



Vantage Pavers and Discover Pavers – Dimensionally Compatible

Hardscape professionals often have grand visions when designing and installing outdoor spaces but are sometimes faced with the issue that the colors, sizes and textures they desire don't come in the same product line. With that core concern in mind, County Materials has added four new paver lines to enhance installation efficiency, ensure product availability, and enable hardscape designers and installers to combine more colors, shapes, and textures in a seamless pattern with endless potential for design.

County Materials has introduced our four lines of Discover™ Pavers, Grand Discover™ Pavers, Vantage™ Pavers and Grand Vantage™ Pavers to make the material selection and design process streamlined and simple. Our dimensionally compatible paver series have been crafted to work together to create an endless number of designs using different size modules, colors and textures; all are backed by the strength and longevity of concrete hardscape products.

Additionally, they are dimensionally designed for easy installation, and work seamlessly with our original series of Elements™ Paving Stones to provide even greater opportunities for accent, banding and inlay options. Equally as important, Discover, Grand Discover, Vantage, and Grand Vantage pavers are stock paver series that are readily available through our distribution centers.



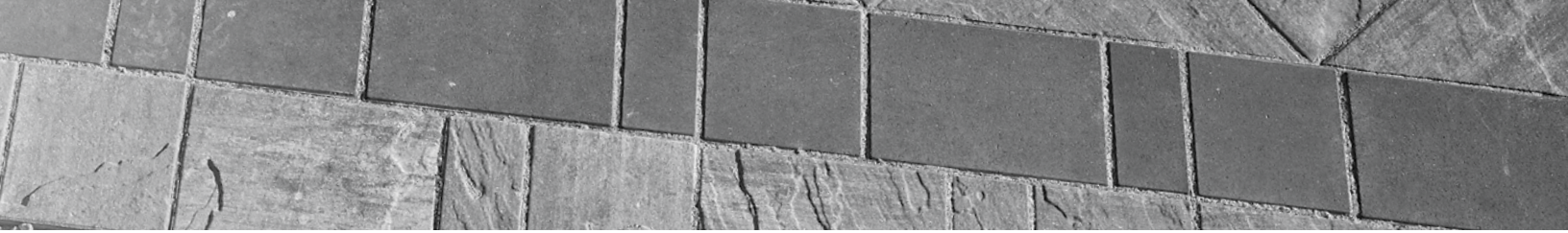

Vantage Pavers and Discover Pavers

Both are offered in two size modules. Sizes and Textures can be mixed.

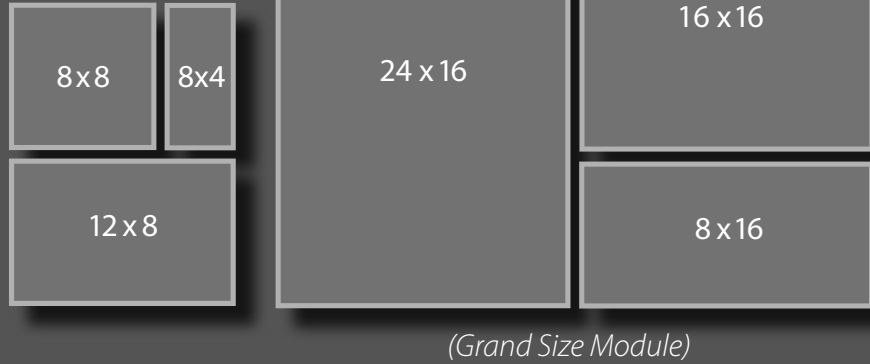

The Art and Science of Dimensional Paver Design

Throughout a variety of applications, County Materials' dimensionally compatible pavers will allow different components to work together easily, despite differences in size. This flexibility means individual units can be separated, interchanged and recombined without having to remeasure or manipulate the space. County Materials' dimensionally compatible paver lines are purposefully crafted in a variety of fixed dimensions that can be used singularly, or in conjunction with our other dimensionally compatible paver lines.

Typically, concrete pavers can be installed using a wide variety of layout dimensions. For maximum construction efficiency and economy, we've intentionally manufactured our new four Discover, Grand Discover, Vantage, and Grand Vantage paver lines with dimensional compatibility in mind. Dimensional compatibility coordination will improve installation efficiency, reduce cutting and waste, and lower costs.

County Materials' dimensionally compatible paver series are produced in four-inch increments. Our pavers are crafted with U.S. measurements and are designed to work in combinations or as individual units. As a result, an endless number of patterns can be created using

dimensionally compatible pavers, including our original series of Elements Paving Stones, and our newest lines of Discover, Grand Discover, Vantage and Grand Vantage pavers in a variety of sizes, colors and textures.

Designed to be Compatible with Elements Paving Stones

Elements Paving Stones come in six uniform shapes. Each of the 6 sizes are individually palletized for optimal design functionality. Our four newest product lines, Discover Pavers, Grand Discover, Vantage Pavers and Grand Vantage Pavers, further enhance the value of investing in dimensionally compatible paver systems, and they add more design versatility because of their different surface textures. Discover and Grand Discover Pavers have a contemporary and smooth finished surface like Elements, while Vantage and Grand Vantage Pavers feature a subtle stone/slate surface texture.

All of County Materials' dimensionally compatible pavers are offered in standard colors and can be ordered with custom finishes upon request.

Installation Guidelines- Interlocking Concrete Pavers

County Materials provides general construction guidelines to design professionals and installers of interlocking concrete pavers. For additional installation information, reference the Interlocking Concrete Pavement Institute's (ICPI) Tech Spec Technical Bulletins.

Excavation

- A) Before excavating, call all local utility companies (e.g., phone, gas, electrical) to ensure the area in which you plan to dig is clear of underground utilities.
- B) When excavating, it is important to achieve a slope in increments of 1.5% (3/16" per ft./5 mm per 300 mm), which will allow for proper drainage. The excavation should mirror the final grade of pavement.
- C) The width of your base behind your edge should be equivalent to the thickness of the base.
- D) Grade the bottom of your excavated area. If the natural soil is granular or sandy, the industry recommends you compact the soil with a vibrating plate. If the soil is clay-like, change the soil with a blend of lime and crushed stone prior to compaction. Next, cover it with a layer of geotextile fabric to prevent the contamination of your base (clay and 0-3/4" [0-20 mm] crushed stone).

Base Material

- A) Install your 0-3/4" (0-20 mm) crushed stone base, in 4" (100 mm) lifts with a (minimum 5000 lbs [22 kN] vibrating plate) compactor.
- B) To facilitate compacting, wet your base material thoroughly and compact with a vibrating plate proceeding in all directions. Continue this process until you achieve your desired height. At this stage, you can verify your final height with the help of a paver.
- C) Base tolerance $\pm 3/8"$ (10 mm) for every 10' (3-m) increment.

The Setting Bed

- A) On your compacted crushed base, install two pipes (outside diameter of 1" (25 mm)). Grade the concrete sand with the help of a straight edge. If the base isn't properly graded and smooth, imperfections will be evident in the finishing grade of the pavement.
- B) Bedding sand should not be compacted until all paving stones have been laid down. Passing the vibrating plate over your paving stones causes them to settle approximately 3/8" (10 mm) into your bedding sand.

Installation Guidelines- Interlocking Concrete Pavers

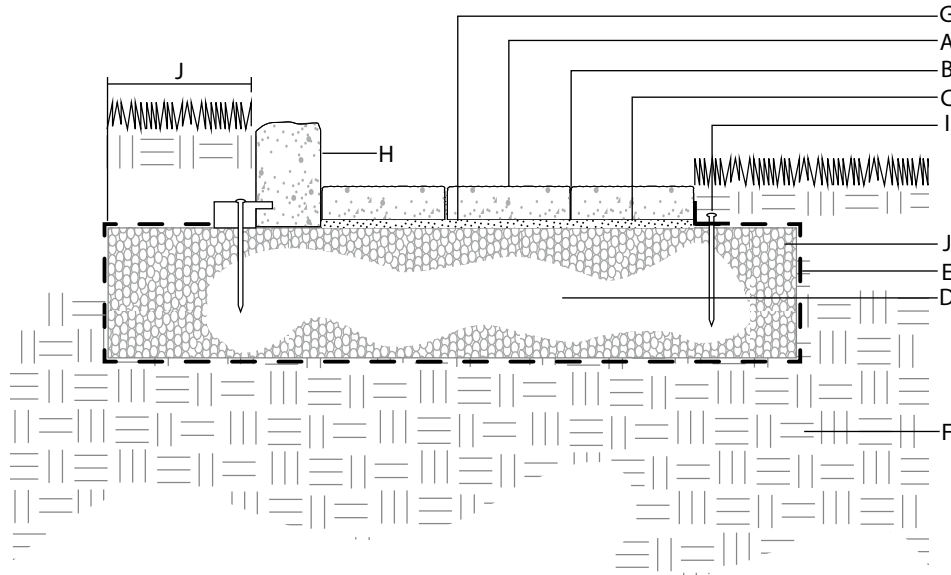

- A County Materials Concrete Paving Stones (ASTM C936). Paver surface pitch for positive drainage (minimum 2%. 1/4"/ft, [6mm/300mm])
- B Sand joint material (ASTM C144)
- C Sand setting bed: 1" (25mm) before compaction (ASTM C33)
- D Base stone depth varies with soil type, climate, load and water table
- E Geotextiles
- F Subgrade soil; classified and properly graded
- G Geotextile strip to prevent downward sand migration
- H Edge restraint
- I Edge restraint (PVC, aluminum) anchored to base stone
- J Base stone extends beyond edge of pavement to a minimum of 6" (150 mm) or equal to depth of base stone

INTERLOCKING CONCRETE PAVEMENT INSTALLATION

Typical cross section

Mock-Up Sample Units

Before project installation begins, construct a separate mock-up sample panel of not less than 7 feet by 7 feet with units in the pattern, type, color, finish and shape specified. This sample panel must be completed for evaluation of surface preparation techniques, application workmanship, as well as the application methods for any jointing materials, and cleaning and sealing agents.

Installation of Paving Stones

- A) Once the choice of paving stones and the design has been finalized, it is recommended that you start installing your pavers at a 90-degree angle. This is realized by proceeding as follows: measure a first horizontal line 3' (1-m), and a second line of 4' (1.2 m) perpendicular to the first. You then connect a third straight line of 5' (1.5 m) which will form a triangle, and the result will be a perfect 90-degree angle. While installing your paving stones, walk on the installed pavers, and fill in gaps caused by the pipes with concrete sand.
- B) Because concrete units are manufactured with high quality, naturally-mined aggregates and materials, variations in color or shading should be expected in products that are manufactured at different times and in units having different shapes. This color or shading variation is acceptable in the industry.

The contractor must install concrete units in accordance with the landscaping industry's best practices, according to ICPI standard specifications, and the manufacturer's instructions. Install units from several pallets to ensure distribution of color. County Materials is not liable or responsible for loss or damage resulting from improper storage, handling, maintaining the products or failure to follow installation instructions. Follow recommended warnings, advisories and instructions.

- C) You may use a chalk line to mark the stones to be cut along the borders, after which you can then cut using a guillotine or a concrete saw. When cutting paving stones, always wear personal protective equipment.
- D) Once you finish installing your paving stones, you can then install the specified edge restraint. In a vehicular traffic application, the concrete must be reinforced using steel rods.

Installation Guidelines- Concrete Slabs

County Materials provides general construction guidelines to design professionals and installers of concrete slabs. For additional installation information, reference the Interlocking Concrete Pavement Institute's (ICPI) Tech Spec Technical Bulletins.

Excavation

- A) Before excavating, call all local utility companies (e.g., phone, gas, electrical) to ensure that the area in which you plan to dig is clear of underground cables or wires. If any are found, please notify the appropriate companies before you continue.
- B) When excavating, it is important to achieve a slope in increments of 3/16" per ft. (5 mm per 300 mm) which will allow for proper drainage. The excavation should mirror final grade of pavement.
- C) The width of your base behind your edge should be equivalent to the thickness of the base.
- D) Grade the bottom of your excavated area. If the natural soil is granular or sandy, the industry recommends you compact the soil with a vibrating plate. If the soil is clay-like, change the soil with a blend of lime and crushed stone prior to compaction. Next, cover it with a layer of geotextile membrane to prevent the contamination of your base (clay and 0-3/4" [0-20 mm] crushed stone).

Base Material

- A) Install your 0-3/4" (0-20 mm) crushed stone base, in 4" (100 mm) lifts with a (minimum 5000 lbs [22 kN] vibrating plate) compactor.
- B) To facilitate compacting, wet your base material thoroughly and compact with a vibrating plate proceeding in all directions. Continue this process until you achieve your desired height. At this stage, you can verify your final height with the help of a paver.
- C) Base tolerance $\pm 3/8"$ (10 mm) for every 10' (3-m) increment.

The Setting Bed

- A) On your compacted crushed base, install two pipes (outside diameter of 1" (25 mm). Grade the concrete sand with the help of a straight edge. If the base isn't properly graded and smooth, imperfections will be evident in the finishing grade of the pavement.
- B) Once the setting bed is graded, pre-compact with a hand tamper, then lightly fluff.

Installation Guidelines- Concrete Slabs

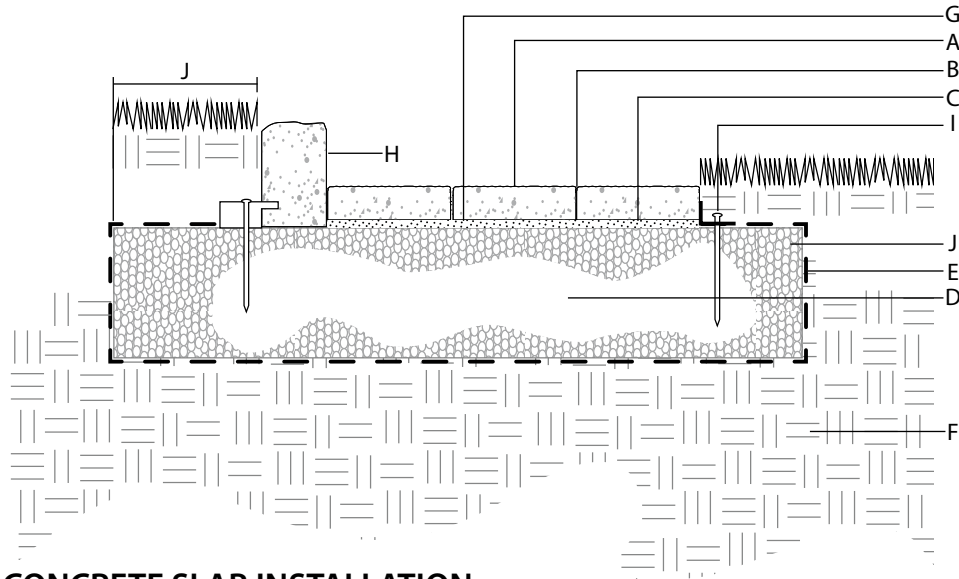

- A County Materials Concrete Slabs.Paver surface pitch for positive drainage (minimum 2%. 1/4"/ft, [6mm/300mm])
- B Sand joint material (ASTM C144)
- C Sand setting bed: 1" (25mm) (ASTM C33)
- D Base stone depth varies with soil type, climate, load and water table
- E Geotextiles
- F Subgrade soil; classified and properly graded
- G Geotextile strip to prevent downward sand migration
- H Edge restraint
- I Edge restraint
- J Base stone extends beyond edge of pavement to a minimum of 6" (150 mm) or equal to depth of base stone

CONCRETE SLAB INSTALLATION

Typical cross section

Installation of Slabs

- A) Once the choice of slabs and the design has been finalized, it is recommended you start installing your slabs at a 90-degree angle. To obtain a 90-degree angle you should use the rule of a 3/4/5-triangle. This is realized by proceeding as follows: measure a first horizontal line of 3' (1-m), and a second line of 4' (1.2 m) perpendicular to the first. You then connect a third straight line of 5' (1.5 m) which will form a triangle, and the result will be a perfect 90-degree angle. While installing your slabs, walk on the installed slabs, and fill in gaps caused by the pipes with concrete sand.
- B) Color of concrete products may vary significantly between production lots. Install concrete slabs from several pallets to ensure distribution of color. Furthermore, you should proceed with the cubes from top to bottom.
- C) You may use a chalk line to mark the stones to be cut along the borders, after which you can then cut using a concrete saw. When cutting slabs, always wear personal protective equipment, including protective ear and eye wear.
- D) Once you finish installing your slabs, you can install the specified edge restraint.

Care & Maintenance- Interlocking Concrete Pavers & Slabs

Color Selection

Colors shown may vary from actual hues and should only be used as a guide. Refer to actual product samples for final color selection. Because concrete products are manufactured with high quality, naturally-mined aggregates and materials, variations in color or shading should be expected in products that are manufactured at different times and in units having different shapes. This color or shading variation is acceptable in the industry. County Materials recommends immediately verifying the product and color upon receipt, and prior to opening pallets. For any discrepancies, contact your local County Materials representative before installation. Use of product constitutes acceptance.

Proper Color Distribution and Installation Techniques

Color of concrete products may vary significantly between production lots. Install concrete units from several pallets to ensure distribution of color. The contractor must install concrete units in accordance with the landscape industry's best practices according to ICPI and NCMA Standard Specifications and the manufacturer's instructions. County Materials is not liable or responsible for loss or damage resulting from improper use, handling or failure to follow installation instructions. Follow all applicable warnings, advisories, and instructions.

Efflorescence

Efflorescence is a naturally occurring process in all concrete products which may appear in the form of a white powdery film on the unit's surface. Efflorescence may be more perceivable in darker colors. It does not, in any way, compromise the functionality or the structural integrity of the product or your installation. Although efflorescence cannot be prevented, it will wash off over time or it can be cleaned with an industry cleaner. County Materials accepts no responsibility or liability for the occurrence of efflorescence.

Washing Guidelines

Seasonal maintenance is recommended for all County Materials' landscape products. General washing guidelines are provided for the following: organic stains, including fruit, soil and leaf residue, algae and moss stains, and efflorescence. For efflorescence stains, wash with a hose and stiff broom.

Cleaning Agents

Concrete cleaning agents are not required but are an option for all County Materials' Interlocking Pavers and Slabs. There are many different cleaning agents specific to application requirements and desired results. Use of the cleaning agent must comply with all instructions provided by the cleaning agent manufacturer, and the cleaning agent method must be performed on a separate mock-up sample not less than 7 feet by 7 feet prior to Buyer approval. County Materials accepts no responsibility or liability for the use of cleaning agents on our Interlocking Pavers and Slabs.

Construction Residue

A possible by-product of cutting concrete units during installation with a saw is residue-filled water or concrete dust. Residue-filled water or re-hydrated dust can cling to the surface of units and leave a concrete stain. It is recommended to wash and remove the water or concrete dust from the surface of the pavers before it dries. Construction residue can also happen through soil disturbance or environmental elements. These contaminants should be removed immediately; they do not compromise the functionality or the structural integrity of the product or your installation. County Materials accepts no responsibility or liability for the occurrence of construction residue or concrete stains.

Sealing

Concrete sealers, though not required, may minimize damage from deicing chemicals, prevent staining and enhance the color. If you choose to use a sealer, it is recommended to use a penetrating sealer which is breathable. Consult a County Materials' sales representative for complete sealing instructions. County Materials Corporation accepts no responsibility or liability for the use of sealing agent of on our Interlocking Pavers & Slabs.

Care & Maintenance- Interlocking Concrete Pavers & Slabs

Slip Resistance & Ice Removal

Sand is the only material recommended to improve slip resistance on concrete product surfaces. Avoid the use of deicers and fertilizers which contain the following chemicals or compounds: Sodium chloride (NaCl "Rock Salt"), Calcium chloride (CaCl₂), Magnesium chloride (MgCl₂), Ammonium nitrate (NH₄NO₃), Ammonium sulfate (NH₄SO₄) or Urea. Use of these chemicals may be harmful to concrete products, especially when used in excess. County Materials Corporation accepts no responsibility or liability for the use of slip resistant products.

Delivery & Storage

Buyer(s) of Interlocking Concrete Pavers & Slabs manufactured by County Materials Corporation shall inspect the material within 48 hours of receipt (the "Inspection Period") to ensure that the style, color, etc., comply with the specifications, and that the material is not damaged or defective. The buyer(s) will be deemed to have accepted the material unless it notifies County Materials Corporation in writing of any non-conforming material during the Inspection Period and furnishes such written evidence or other documentation as required by County Materials Corporation. Material that does not meet the specifications, is defective, or is damaged should not be used for construction.

Once the material is delivered, the buyer(s) is solely responsible for protecting the material from damage, including from snow, excessive mud, wet concrete or any agent that will bond to or damage the material. County Materials Corporation is not responsible for any damage to the material that occurs after delivery.

Reference Only – Landscape Products Specification Guide

This Guide, provided at no cost by County Materials Corporation, is intended to serve only as an informational resource for buyer(s) of Interlocking Concrete Pavers & Slabs manufactured by County Materials Corporation. Every effort has been made to ensure the accuracy of the information presented in this Installation Guide. However, this Guide is provided for reference only and is not a substitute for and does not replace the need for registered professional engineering design and experienced contractor installation. Actual site conditions may vary significantly from those presented in the estimating tables herein. County Materials Corporation strongly urges buyer(s) to exercise diligence and care in the selection, design, installation and use of any construction materials. Review Tech Data Sheets, Care and Maintenance, ICPI and NCMA industry association best practice instructions before starting and/or Buyer approval of Landscape projects. The final determination of the suitability of any information contained in this Installation Guide is the sole responsibility of material buyer(s).

DISCLAIMER OF LIABILITY

COUNTY MATERIALS CORPORATION DISCLAIMS ANY AND ALL LIABILITY FOR DAMAGES OR LOSSES OF ANY KIND OR NATURE TO PERSON(S) OR PROPERTY, INCLUDING, BUT NOT LIMITED TO, DIRECT, INDIRECT, INCIDENTAL, CONSEQUENTIAL OR PUNITIVE DAMAGES, ATTORNEYS' FEES OR COSTS, ARISING OUT OF OR RELATED TO THE USE OF THIS INSTALLATION GUIDE, INCLUDING, BUT NOT LIMITED TO ANY WORK THAT MAY BE PERFORMED BY ANY CONTRACTORS OR INSTALLERS.

WAIVER OF CLAIMS AND AGREEMENT TO HOLD HARMLESS

BY USING THIS INSTALLATION GUIDE, YOU AGREE TO WAIVE ANY AND ALL CLAIMS AGAINST COUNTY MATERIALS CORPORATION, ITS OFFICERS, DIRECTORS, EMPLOYEES, VOLUNTEERS, REPRESENTATIVES, AND AFFILIATES, AND HOLD THEM HARMLESS FOR ANY DAMAGES OR LOSSES OF ANY KIND TO PERSON(S) OR PROPERTY, INCLUDING, BUT NOT LIMITED TO, DIRECT, INDIRECT, INCIDENTAL, CONSEQUENTIAL OR PUNITIVE DAMAGES ARISING OUT OF OR RELATED TO THE USE OF THIS INSTALLATION GUIDE, INCLUDING BUT NOT LIMITED TO THE SELECTION, DESIGN, INSTALLATION OR USE OF ANY MATERIALS, PRODUCTS, STRUCTURES, COMPONENTS OR ASSEMBLIES.

Purchaser is responsible for proper use, handling, maintenance and installation of product as determined by the manufacturer and industry standards. Product has a fitness for a particular purpose. Use and/or application of product not intended by the manufacturer and not in compliance with industry standards is not recommended. Use and/or installation and application are the sole responsibility of the purchaser.

Paver Application, Palletization & Availability Table

Pavers & Slabs	Vehicular Traffic	Pool Deck	Commercial	Pedestrian	How Is This Product Palletized?	Product Availability
Destination® Pavers (70mm)		•		•	4 pc Combo (4 unique sizes / 9 face styles)	Stocked
Dimetta® Pavers (80mm)	•	•	•	•	Individually palletized	Special Order
Discover™ Pavers (70mm)	•	•	•	•	3 pc Combo	Stocked
Grand Discover™ Pavers (70mm)		•		•	3 pc Combo	Stocked
Elements™ Paving Stones - Unit A (70mm)	•	•	•	•	Individual sizes palletized separately	Stocked
Elements™ Paving Stones - Unit B (70mm)	•	•	•	•	Individual sizes palletized separately	Stocked
Elements™ Paving Stones - Unit C (70mm)	•	•	•	•	Individual sizes palletized separately	Stocked
Elements™ Paving Stones - Unit D (70mm)	•	•		•	Individual sizes palletized separately	Stocked
Elements™ Paving Stones - Unit E (70mm)		•		•	Individual sizes palletized separately	Stocked
Elements™ Paving Stones - Unit F (70mm)		•		•	Individual sizes palletized separately	Stocked
Essence™ Wood Grain Plank Pavers (80mm)	•	•	•	•	5 pc Combo	Stocked
Grand Milestone® Pavers (70mm)		•		•	3 pc Combo	Stocked
Influence® Pavers (80mm)	•	•	•	•	5 pc Combo	Stocked
Skylands™ Concrete Deck Pavers (51mm)		•		•	Individually palletized	Stocked
Tranquility® Pavers (70mm)	•	•		•	5 pc Combo	Stocked
Vantage™ Pavers (70mm)	•	•	•	•	3 pc Combo	Stocked
Grand Vantage™ Pavers (70mm)		•		•	3 pc Combo	Stocked
Permeable Pavers						
H ₂ O Pro® Pavers Permeable Paver System - Unit A (80mm)	•	•	•	•	Individual sizes palletized separately	Stocked
H ₂ O Pro® Pavers Permeable Paver System - Unit B (80mm)	•	•	•	•	Individual sizes palletized separately	Stocked
H ₂ O Pro® Pavers Permeable Paver System - Unit C (80mm)	•	•	•	•	Individual sizes palletized separately	Stocked
Harmony™ Permeable Pavers (80mm)	•	•	•	•	3 pc Combo	Special Order
Renewable™ Pavers Permeable Paver System & Sandset Pavers (80mm)	•	•	•	•	Individually palletized	Special Order
Rejuvenate™ Permeable Pavers (80mm)	•	•	•	•	Individually palletize	Stocked



Vantage™ and Grand Vantage™ Pavers

Units & Sizes

Vantage Pavers

D x H x L (Nominal Size)
Inches • Millimeters

A  4 x 2¾ x 8 • 96 x 70 x 196

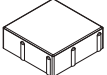
B  8 x 2¾ x 8 • 196 x 70 x 196

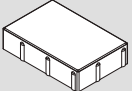
C  8 x 2¾ x 12 • 196 x 70 x 296

SF/Layer	Layers/Pallet	SF/Pallet	Lbs./Pallet
12.45	8	99.6	3175

Grand Vantage Pavers

D x H x L (Nominal Size)
Inches • Millimeters

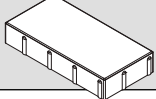
D  8 x 2¾ x 16 • 196 x 70 x 396

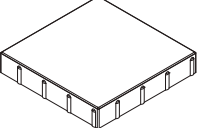
E  16 x 2¾ x 16 • 396 x 70 x 396

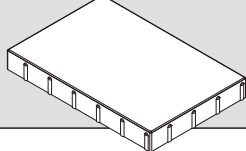
F  16 x 2¾ x 24 • 396 x 70 x 596

SF/Layer	Layers/Pallet	SF/Pallet	Lbs./Pallet
10.16	8	81.28	2600

Layer Configurations

Vantage Pavers

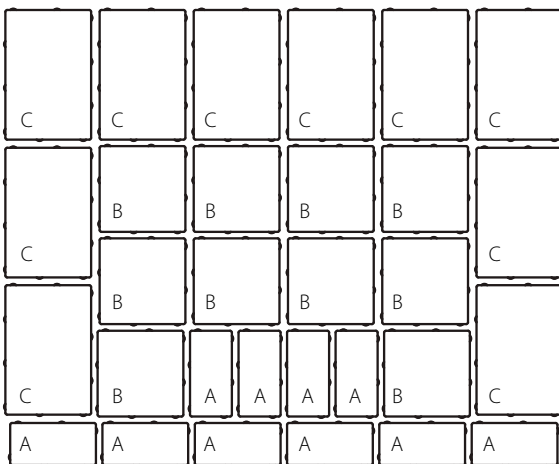

Grand Vantage Pavers

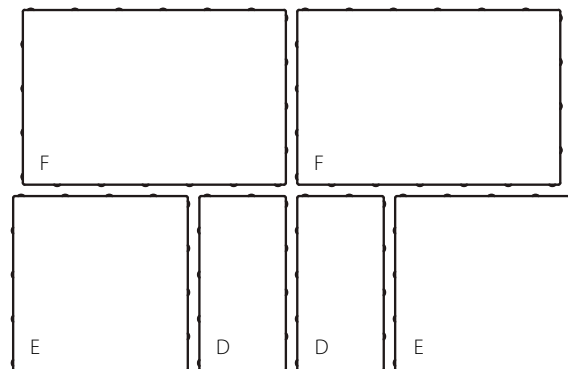

Vantage™ and Grand Vantage™ Pavers

Installation Patterns

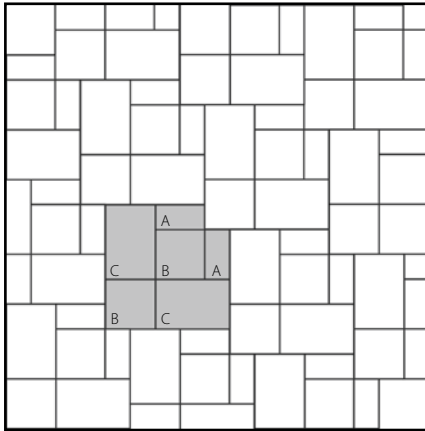

A, B & C Units Pattern #1
A-33% B-33% C-33%

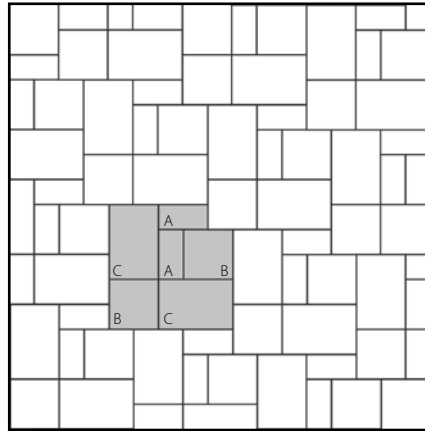

A, B & C Units Pattern #2
A-33% B-33% C-33%

Vantage Pavers units A, B and C shown in the patterns to the left can also be substituted with the Grand Vantage Pavers units D, E and F

A Unit = D Unit
B Unit = E Unit
C Unit = F Unit

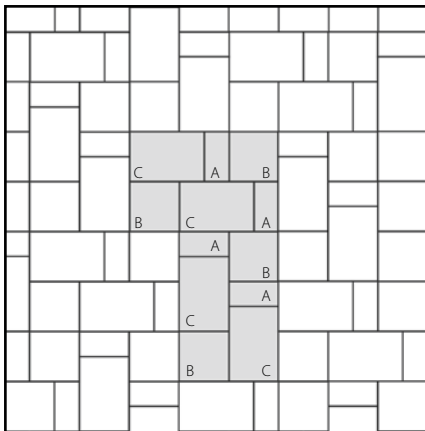

A, B & C Units Pattern #3
A-33% B-33% C-33%

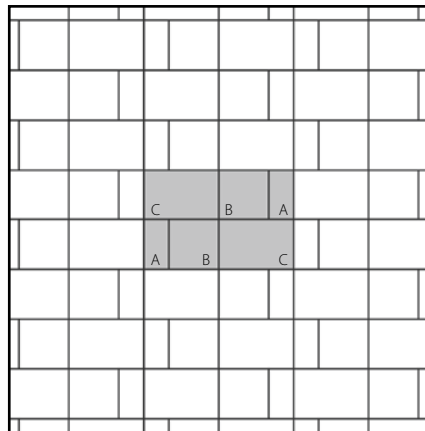

A, B & C Units Pattern #4
A-33% B-33% C-33%

Discover™ and Grand Discover™ Pavers

Units & Sizes

Discover Pavers

D x H x L (Nominal Size)
Inches • Millimeters

A  4 x 2¾ x 8 • 96 x 70 x 196

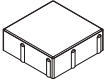
B  8 x 2¾ x 8 • 196 x 70 x 196

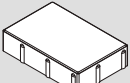
C  8 x 2¾ x 12 • 196 x 70 x 296

SF/Layer	Layers/Pallet	SF/Pallet	Lbs./Pallet
12.45	8	99.6	3175

Grand Discover Pavers

D x H x L (Nominal Size)
Inches • Millimeters

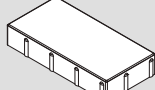
D  8 x 2¾ x 16 • 196 x 70 x 396

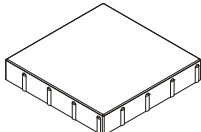
E  16 x 2¾ x 16 • 396 x 70 x 396

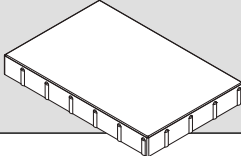
F  16 x 2¾ x 24 • 396 x 70 x 596

SF/Layer	Layers/Pallet	SF/Pallet	Lbs./Pallet
10.16	8	81.28	2600

Layer Configurations

Discover Pavers

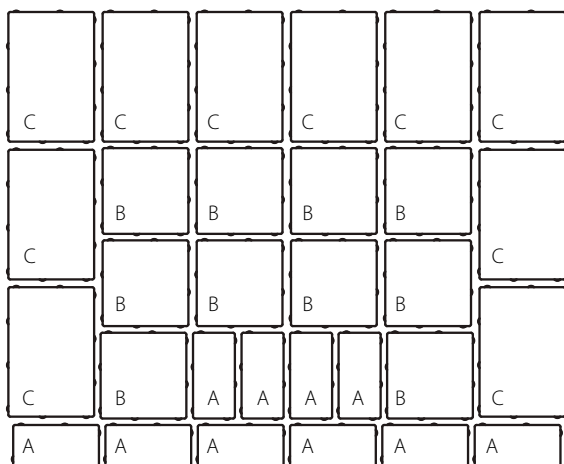

Grand Discover Pavers

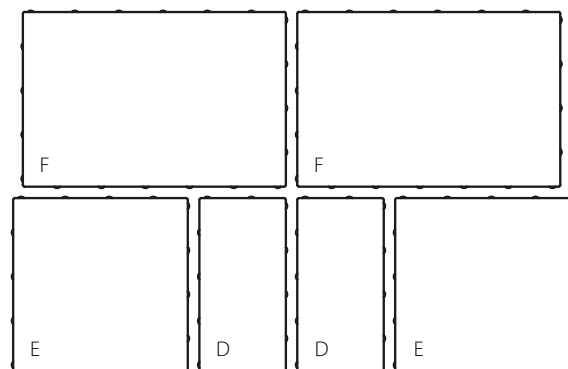

Discover™ and Grand Discover™ Pavers

Installation Patterns

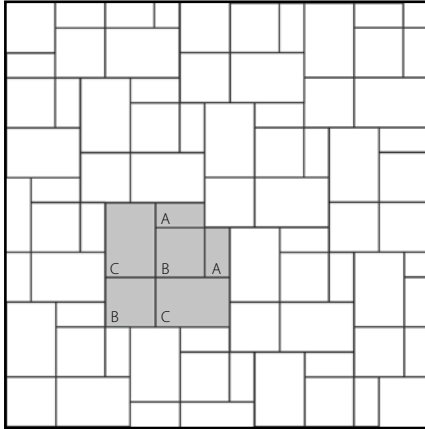

A, B & C Units Pattern #1
A-33% B-33% C-33%

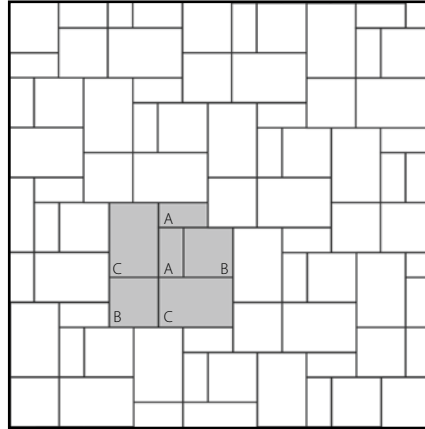

A, B & C Units Pattern #2
A-33% B-33% C-33%

Discover Pavers units A, B and C shown in the patterns to the left can also be substituted with the Grand Discover Pavers units D, E and F

A Unit = D Unit
B Unit = E Unit
C Unit = F Unit

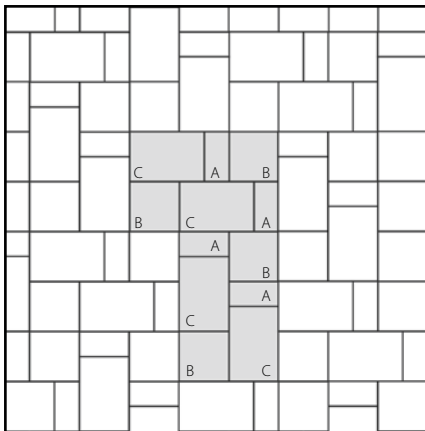

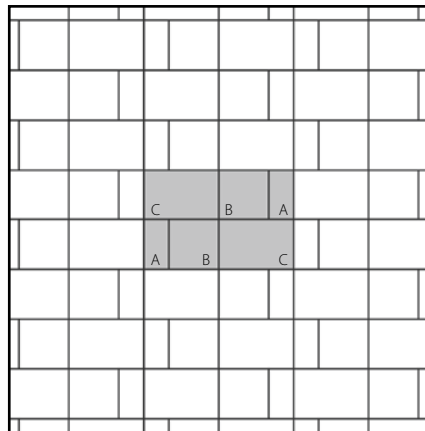

A, B & C Units Pattern #3
A-33% B-33% C-33%



A, B & C Units Pattern #4
A-33% B-33% C-33%

Elements™ Paving Stones

Units & Sizes

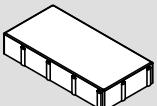
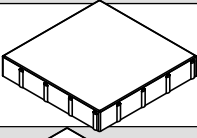
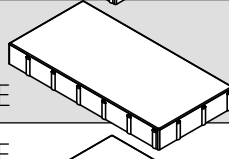
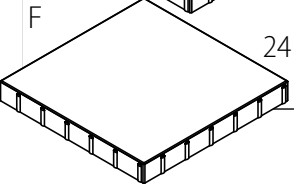
	D x H x L (Nominal Size) Inches • Millimeters	SF/ Unit	Units/ SF	SF/ Layer	Layers/ Pallet	SF/ Pallet	Units/ Layer	Units/ Pallet	Lbs/ Pallet
A 	4 x 2¾ x 8 • 96 x 70 x 196	.22	4.5	11	8	88	50	400	2820
B 	8 x 2¾ x 8 • 196 x 70 x 196	.44	2.25	13.33	8	105.6	30	240	3380
C 	8 x 2¾ x 16 • 196 x 70 x 396	.89	1.13	13.33	8	106.8	15	120	3305
D 	16 x 2¾ x 16 • 396 x 70 x 396	1.78	.56	16.02	6	96.12	9	54	3080
E 	12 x 2¾ x 24 • 296 x 70 x 596	2	.5	12	8	96	6	48	3130
F 	24 x 2¾ x 24 • 596 x 70 x 596	4	.25	16	4	64	4	16	2095

Layer Configurations

(A) 4 x 8 Units

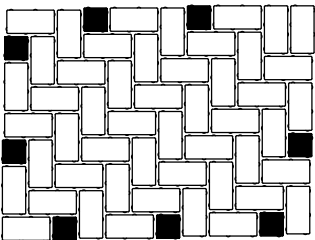

(B) 8 x 8 Units

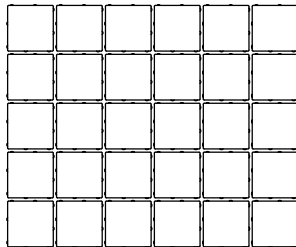

(C) 8 x 16 Units

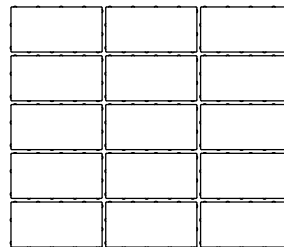

(D) 16 x 16 Units

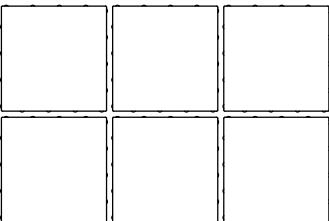

(E) 12 x 24 Units

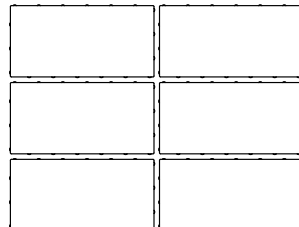

(F) 24 x 24 Units

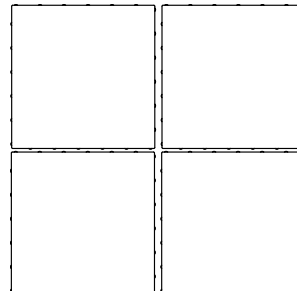

Note: (A) 4" x 8" layer pattern includes 4" x 4" pieces which are included for packaging purpose only and are not recommended for installation

Elements™ Paving Stones

Installation Patterns

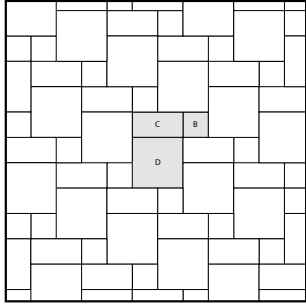

B, C & D Units Pattern #1
B-14% C-29% D-57%

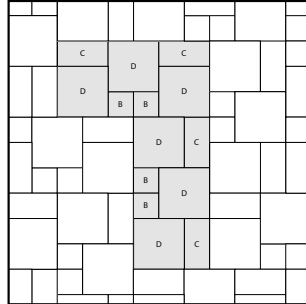

B, C & D Units Pattern #2
B-11% C-22% D-67%

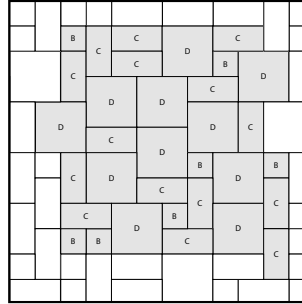

B, C & D Units Pattern #3
B-8% C-36% D-56%

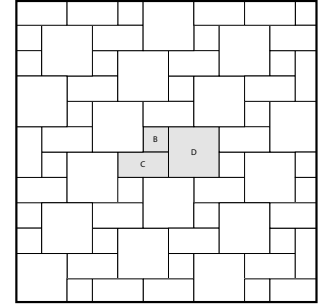

B, C & D Units Pattern #4
B-14% C-29% D-57%

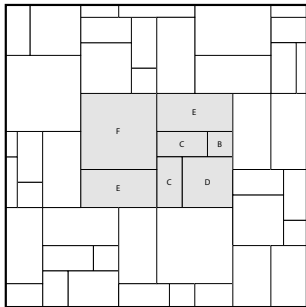

B, C, D, E & F Units Pattern #5
B-4% C-15% D-15% E-33% F-33%

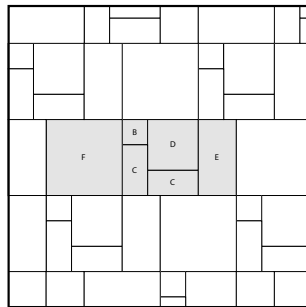

B, C, D, E & F Units Pattern #6
B-4% C-18% D-18% E-20% F-40%

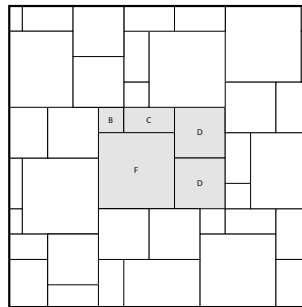

B, C, D & F Units Pattern #7
B-5% C-10% D-40% F-45%

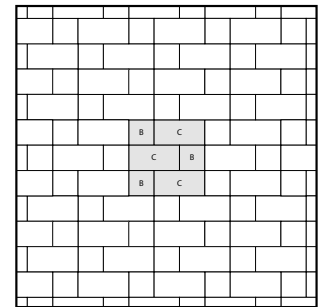

B & C Units Pattern #8
B-33% C-67%

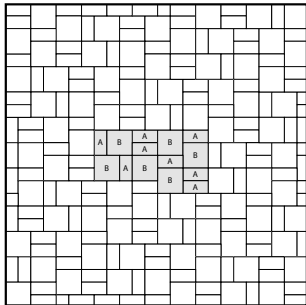

A & B Units Pattern #9
A-40% B-60%

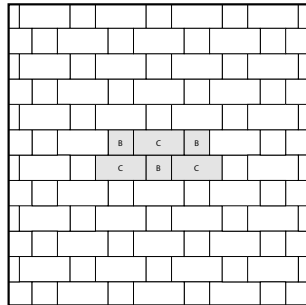

B & C Units Pattern #10
B-33% C-67%

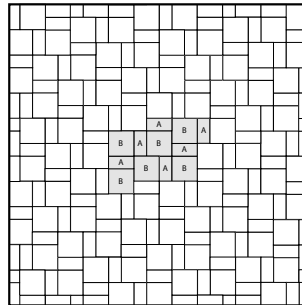

A & B Units Pattern #11
A-33% B-67%

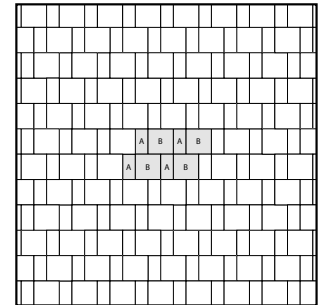

A & B Units Pattern #12
A-33% B-67%

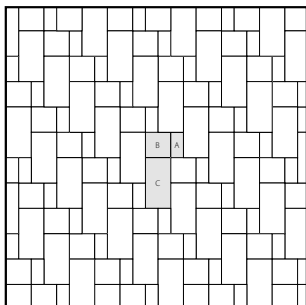

A, B & C Units Pattern #13
A-17% B-29% C-57%

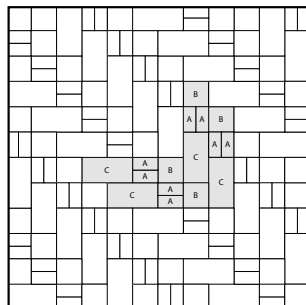

A, B & C Units Pattern #14
A-25% B-25% C-50%

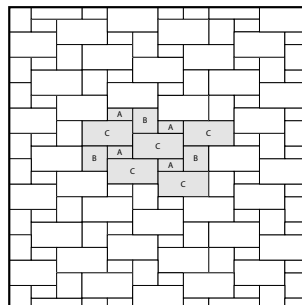

A, B & C Units Pattern #15
A-13% B-20% C-67%

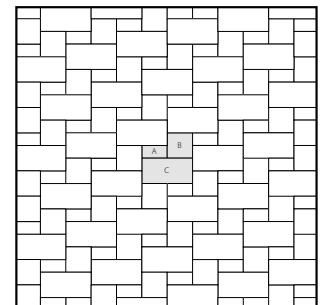

A, B & C Units Pattern #16
A-14% B-29% C-57%

Elements™ Paving Stones

Installation Patterns

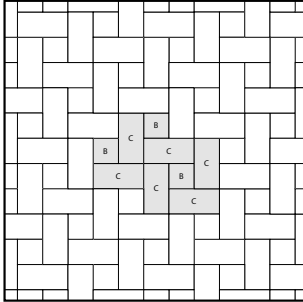

B & C Units Pattern #17
B-20% C-80%

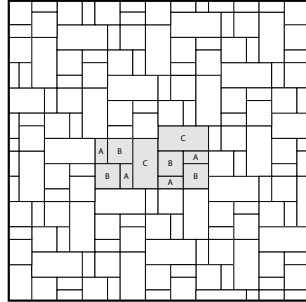

A, B & C Units Pattern #18
A-20% B-40% C-40%

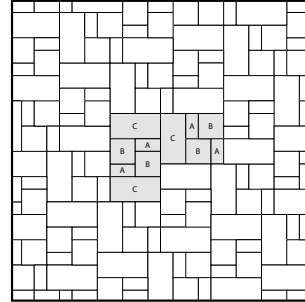

A, B & C Units Pattern #19
A-17% B-33% C-50%

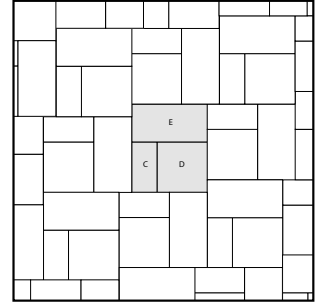

C, D & E Units Pattern #20
C-19% D-38% E-43%

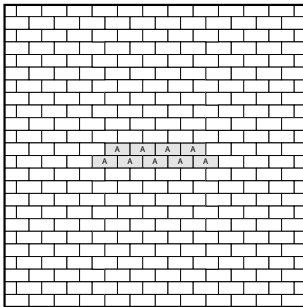

Running Bond
A Units

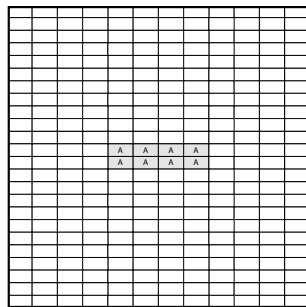

Stack Bond
A Units

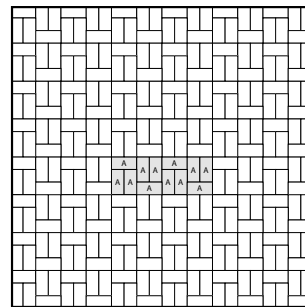

Single Basket Weave
A Units

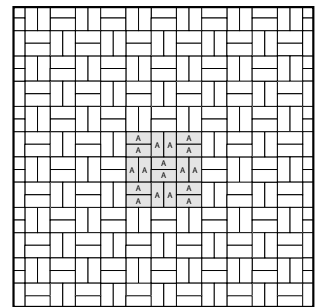

Parquet/Basket Weave
A Units

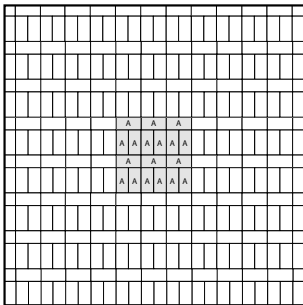

Stack Bond (Variant)
A Units

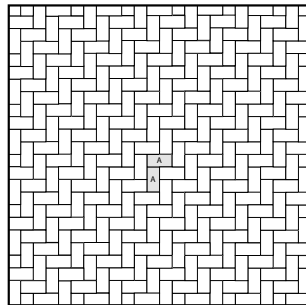

90° Herringbone
A Units

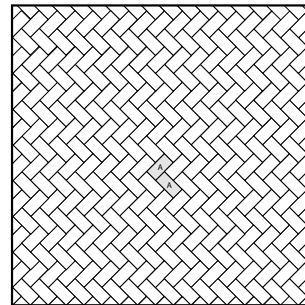

45° Herringbone
A Units

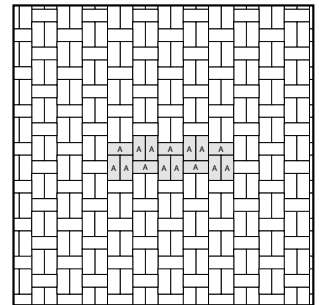

Single Offset Basket Weave
A Units

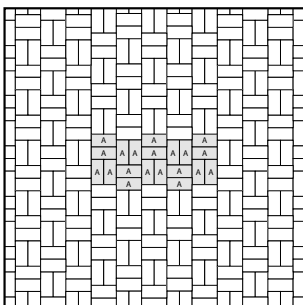

Double Offset Basket Weave
A Units

Units & Sizes

Discover Pavers with Glow Path Technology

D x H x L (Nominal Size)
Inches • Millimeters

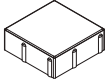
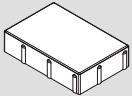
A		4 x 2¾ x 8 • 96 x 70 x 196
B		8 x 2¾ x 8 • 196 x 70 x 196
C		8 x 2¾ x 12 • 196 x 70 x 296

SF/Layer	Layers/Pallet	SF/Pallet	Lbs./Pallet
12.45	8	99.6	3175

Layer Configurations

Discover Pavers with Glow Path Technology

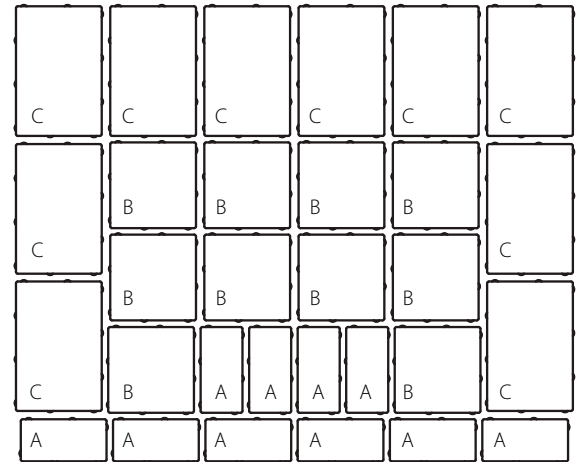

Installation Patterns

Discover Pavers with Glow Path Technology

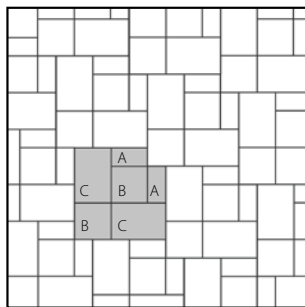

A, B & C Units Pattern #1
A-33% B-33% C-33%

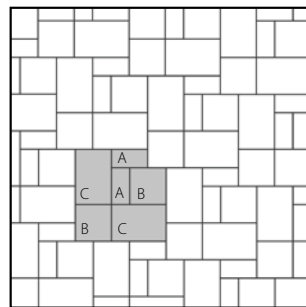

A, B & C Units Pattern #2
A-33% B-33% C-33%

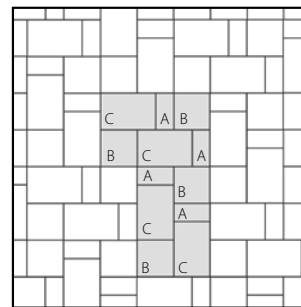

A, B & C Units Pattern #3
A-33% B-33% C-33%

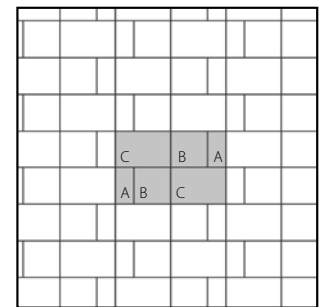

A, B & C Units Pattern #4
A-33% B-33% C-33%

Units & Sizes

Elements Pavers with Glow Path Technology

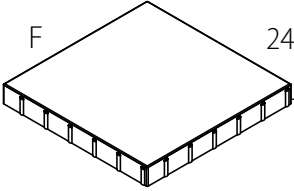
	D x H x L (Nominal Size) Inches • Millimeters	SF/ Unit	Units/ SF	SF/ Layer	Layers/ Pallet	SF/ Pallet	Units/ Layer	Units/ Pallet	Lbs/ Pallet
A 	4 x 2¾ x 8 • 96 x 70 x 196	.22	4.5	11	8	88	50	400	2820
F 	24 x 2¾ x 24 • 596 x 70 x 596	4	.25	16	4	64	4	16	2095

Layer Configurations

Elements Pavers with Glow Path Technology

(A) 4 x 8 Units

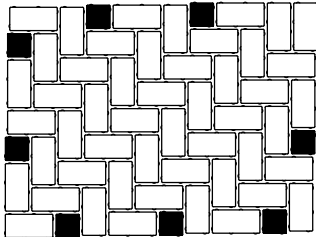

(F) 24 x 24 Units

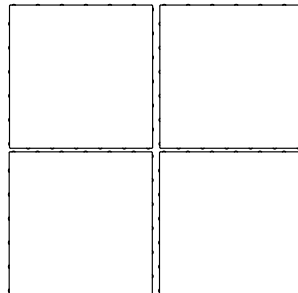

Note: (A) 4" x 8" layer pattern includes 4" x 4" pieces which are included for packaging purpose only and are not recommended for installation

Note: When pavers are exposed to 20 minutes of sunlight you can observe 6-8 hours of glow after sunset. The glow is best seen in dark areas where ambient light is not present. If pavers are installed in shaded areas, the intensity of the glow will vary. However the glow chip is charged by UV rays, this allows the product to still perform on cloudy or overcast days.

Installation Patterns

4 x 8 Elements Pavers with Glow Path Technology

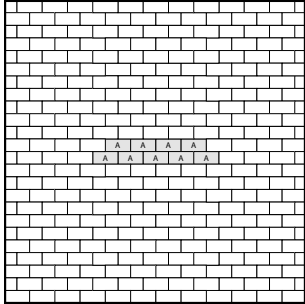

Running Bond
A Units

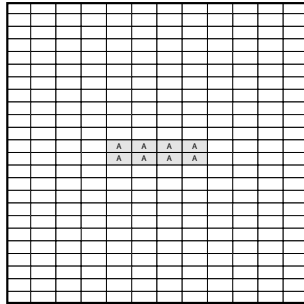

Stack Bond
A Units

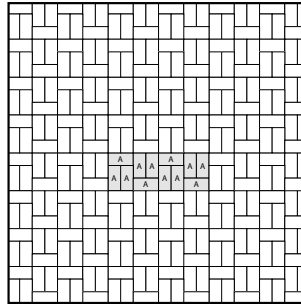

Single Basket Weave
A Units

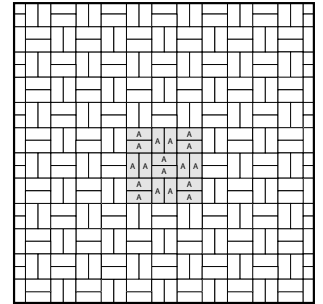

Parquet/Basket Weave
A Units

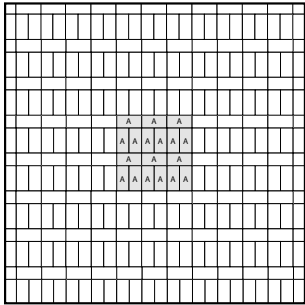

Stack Bond (Variant)
A Units

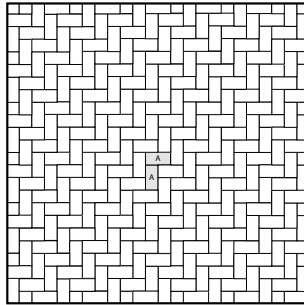

90° Herringbone
A Units

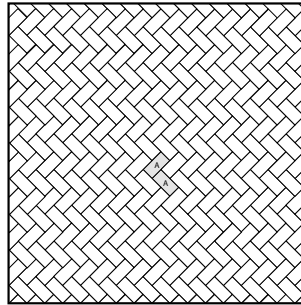

45° Herringbone
A Units

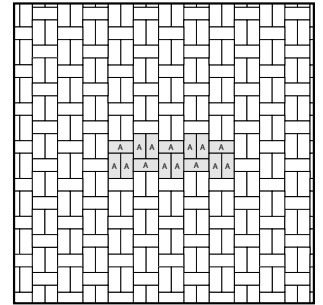



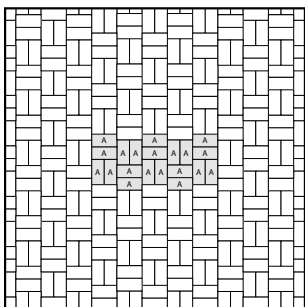

Single Offset Basket Weave
A Units



Double Offset Basket Weave
A Units

Destination® Pavers

Units & Sizes

		D x H x L (Nominal Size) Inches • Millimeters
A		2¾ H • 70H (D & L Vary)
B		2¾ H • 70H (D & L Vary)
C		2¾ H • 70H (D & L Vary)
D		2¾ H • 70H (D & L Vary)
E		2¾ H • 70H (D & L Vary)

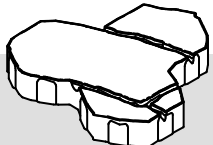
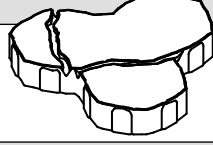
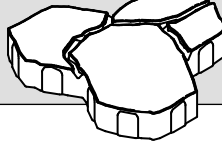
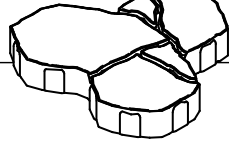
		D x H x L (Nominal Size) Inches • Millimeters
F		2¾ H • 70H (D & L Vary)
G		2¾ H • 70H (D & L Vary)
H		2¾ H • 70H (D & L Vary)
I		2¾ H • 70H (D & L Vary)

SF/Layer	Layers/Pallet	SF/Pallet	Lbs./Pallet
11.11	8	88.88	2840

Layer Configuration

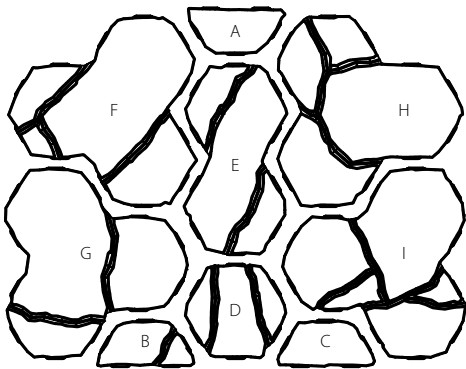

Note: Textured paver and patio stone surfaces require a buffer between the plate compactor and the paver surface to prevent scuffing. Refer to County Materials' Interlocking Concrete Paver or Slab Installation Guidelines, or contact County Materials for information.

Installation Patterns

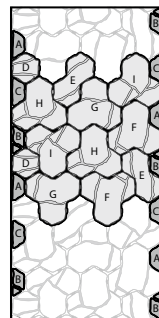
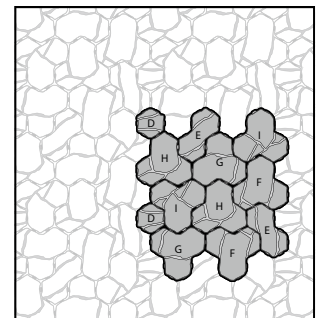
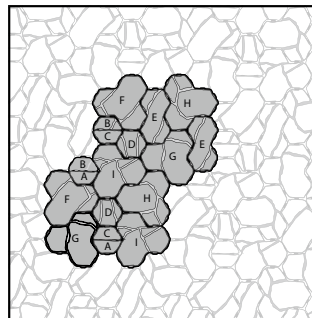

Sidewalk Installation Pattern

* Approximately 57.5" in width

Essence™ Wood Grain Plank Pavers

Units & Sizes

D x H x L (Nominal Size)
Inches • Millimeters

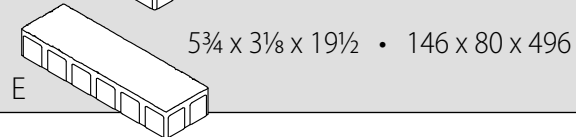
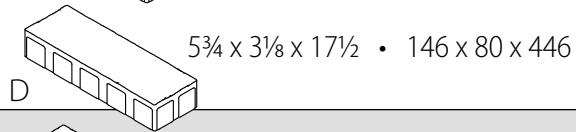
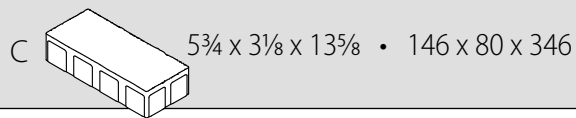
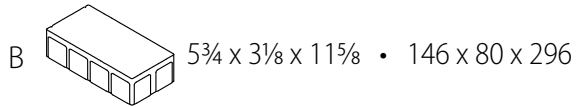
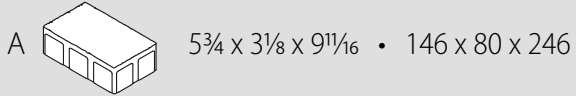

SF/Layer	Layers/Pallet	SF/Pallet	Lbs./Pallet
10.74	8	85.92	3210

Layer Configuration

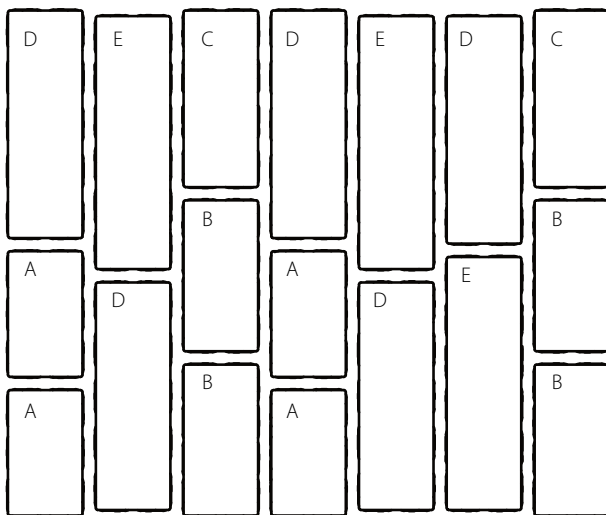

Grand Milestone® Pavers

Units & Sizes

D x H x L (Nominal Size)
Inches • Millimeters

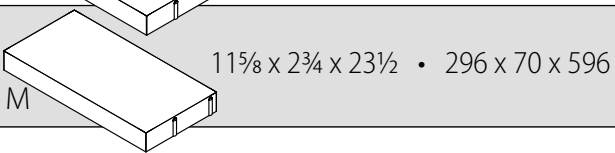
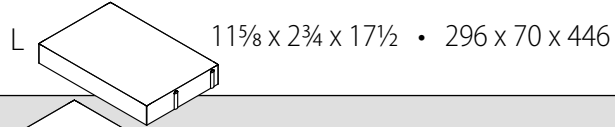
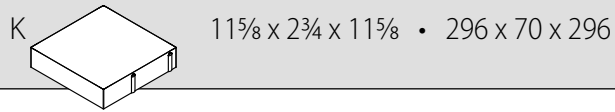

SF/Layer	Layers/Pallet	SF/Pallet	Lbs./Pallet
11.36	8	90.88	2970

Layer Configuration

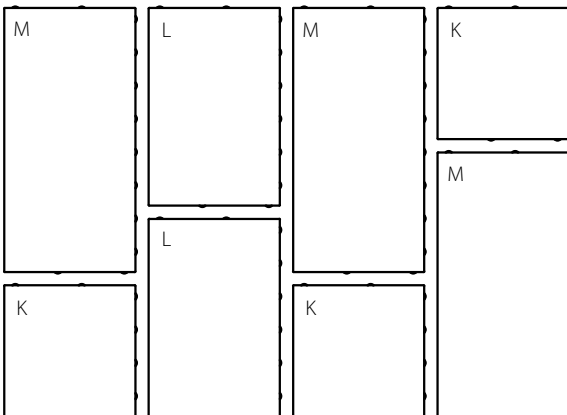

Note: Textured paver and patio stone surfaces require a buffer between the plate compactor and the paver surface to prevent scuffing. Refer to County Materials' Interlocking Concrete Paver or Slab Installation Guidelines, or contact County Materials for information.



Influence[®] Pavers

Units & Sizes

D x H x L (Nominal Size)
Inches • Millimeters

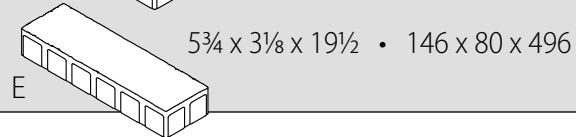
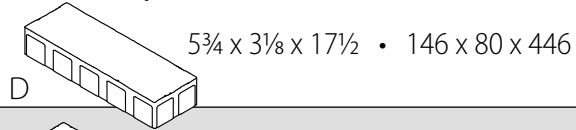
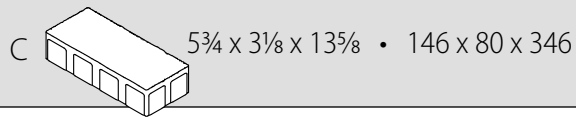
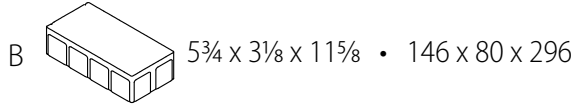
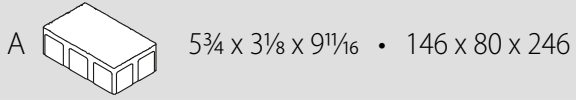

SF/Layer	Layers/Pallet	SF/Pallet	Lbs./Pallet
10.74	8	85.92	3210

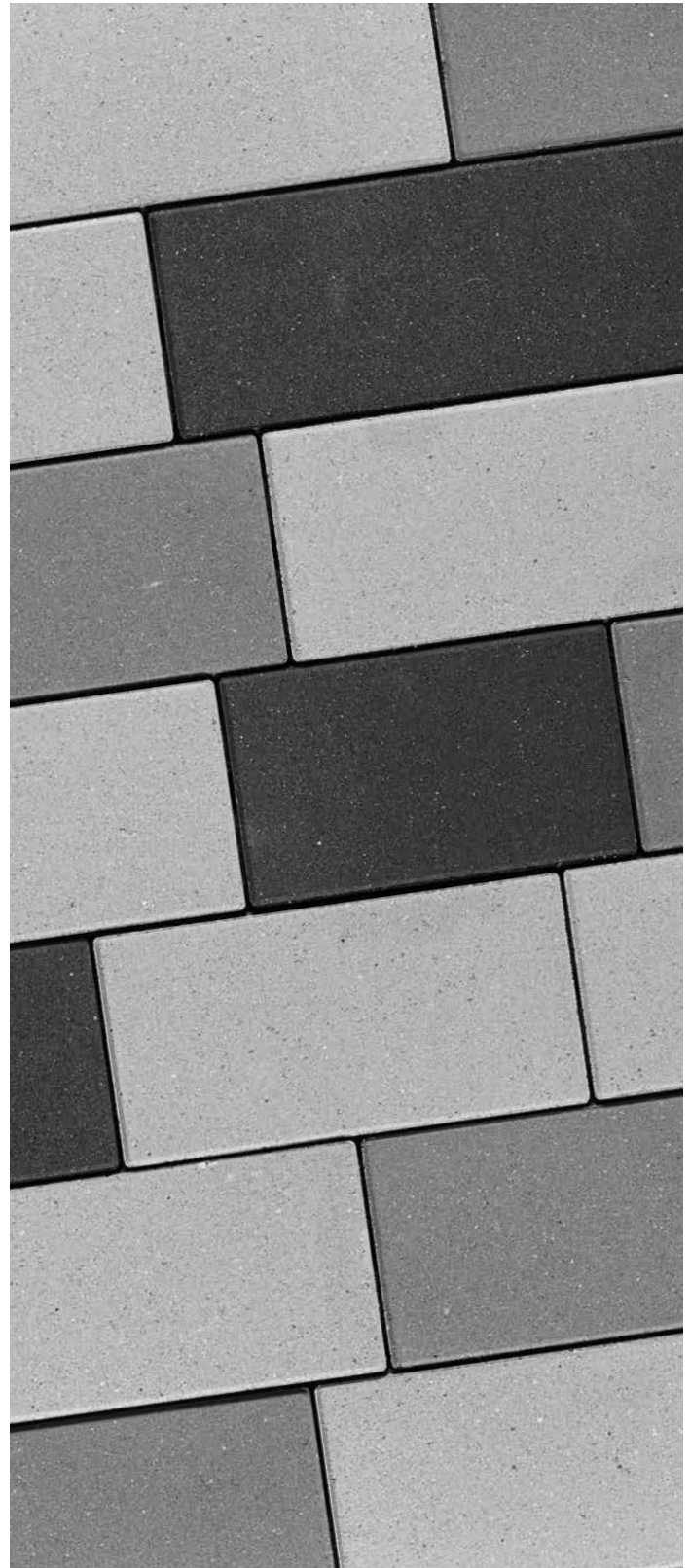

Layer Configuration

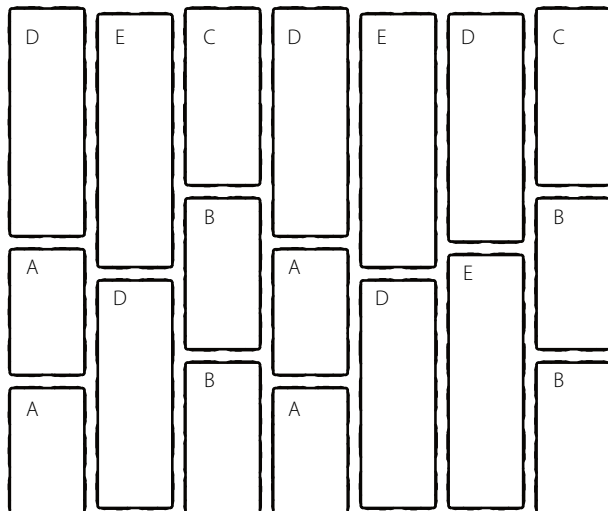

Skylands™ Concrete Deck Pavers

Units & Sizes

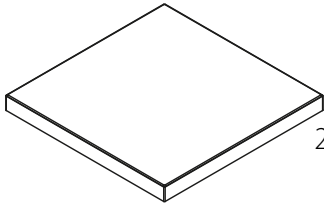

D x H x L (Nominal Size)
Inches • Millimeters

23¹³/₁₆ x 2 x 23¹³/₁₆ • 605 x 51 x 605

SF/Unit	Units/SF	SF/Pallet	Units/Pallet	Lbs/Pallet
4	.25	92	23	2300

Typical Pedestal Installation

Site layout and elevations are necessary to determine the quantity and heights of pedestals needed for each project.

Please send to County Materials for assistance or contact Customer Service at 800-242-7733 or by email at info@countymaterials.com.

Top View

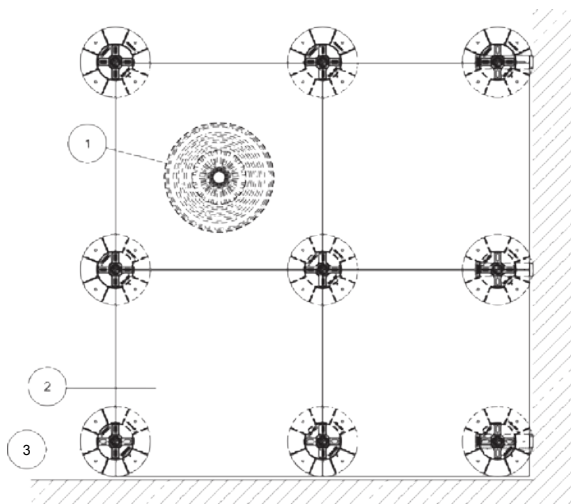

Side View

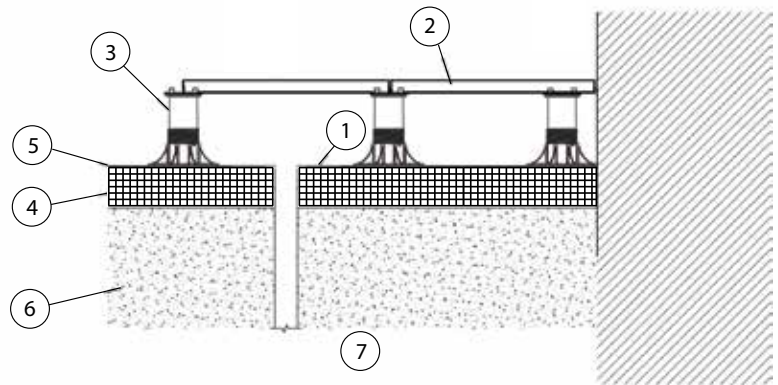

- 1 - Roof Drain
- 2 - Paver
- 3 - Adjustable Paving Support
- 4 - Insulation or Protection Board

- 5- Waterproofing Membrane
- 6 - Concrete Slab
- 7 - Pipes

Skylands™ Concrete Deck Pavers



Tranquility® Pavers

Units & Sizes

D x H x L (Nominal Size)
Inches • Millimeters

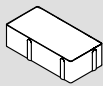
A  9¼ x 2¾ x 4⅝ • 235 x 70 x 117

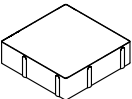
B  9¼ x 2¾ x 9¼ • 235 x 70 x 235

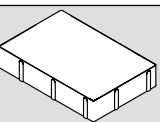
C  14 x 2¾ x 9¼ • 356 x 70 x 248

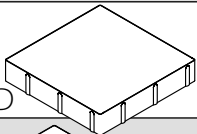
D  14 x 2¾ x 14 • 356 x 70 x 356

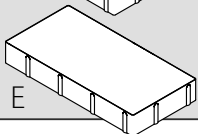
E  18¼ x 2¾ x 9¼ • 464 x 70 x 248

SF/Layer	Layers/Pallet	SF/Pallet	Lbs./Pallet
10.77	8	86.16	2750



Layer Configuration

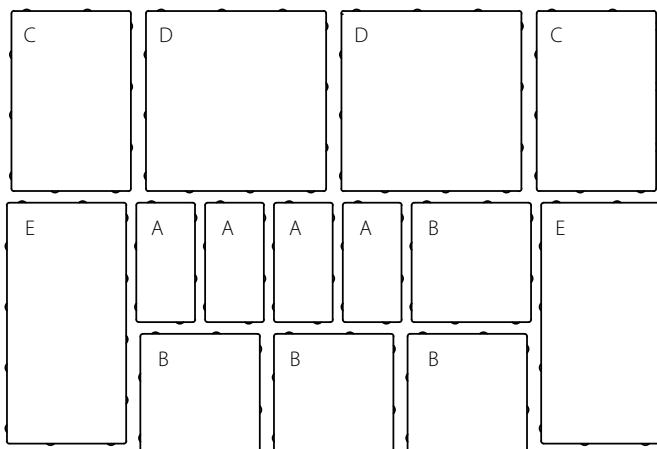

Tranquility® Pavers

Installation Patterns

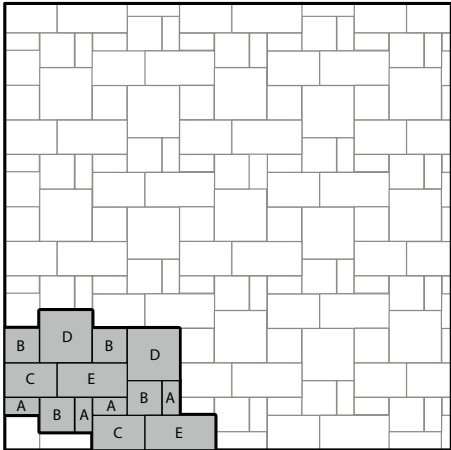

A, B, C, D & E Units
A-7% B-23% C-19% D-27% E-24%

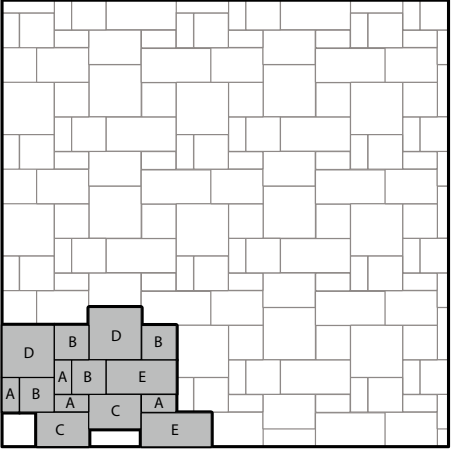

A, B, C, D & E Units
A-7% B-23% C-19% D-27% E-24%

Note: Textured paver and patio stone surfaces require a buffer between the plate compactor and the paver surface to prevent scuffing. Refer to County Materials' Interlocking Concrete Paver or Slab Installation Guidelines, or contact County Materials for information.



Units & Sizes

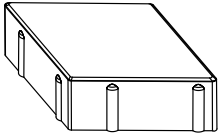

D x H x L (Nominal Size)
Inches • Millimeters
13 x 3 1/8 x 7 3/4 • 330 x 80 x 197

Note: Dimetta Pavers are special order only

SF/Unit	Units/SF	SF/Layer	Layers/Pallet	SF/Pallet	Units/Layer	Units/Pallet	Lbs/Pallet
.37	2.7	9.25	8	74	25	200	2700

Layer Configuration

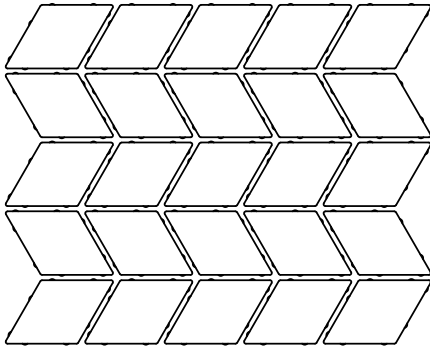

Notes:

- Textured paver and patio stone surfaces require a buffer between the plate compactor and the paver surface to prevent scuffing. Refer to County Materials' Interlocking Concrete Paver or Slab Installation Guidelines, or contact County Materials for information.
- Making (2) cuts from corner to corner on one unit allows for a multitude of additional pattern designs.
- When working around an object (i.e. firepit) make sure to use string lines for proper alignment, keeping joints and tips in line.
- Keep joints snug but not tight- Allow enough room to accommodate slight adjustment in units to keep joints in line, especially when multiple points come together in a pattern.

Installation Patterns

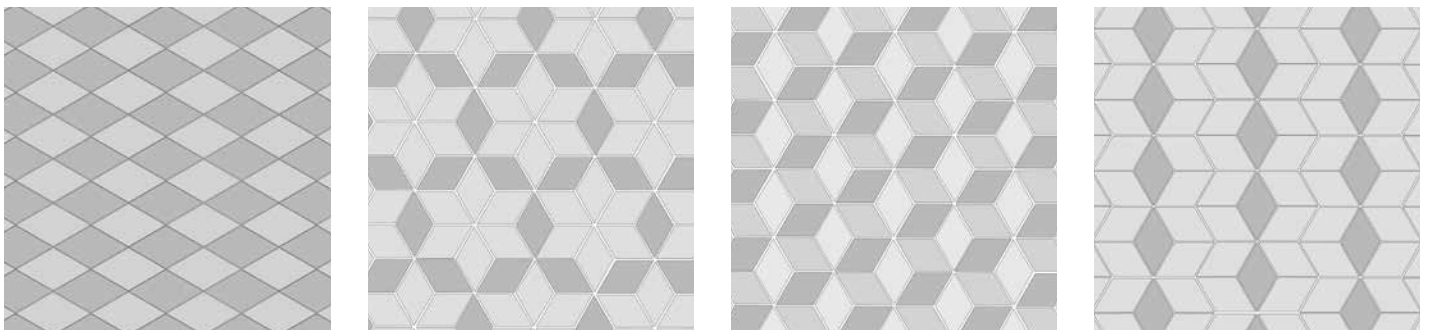





Permeable Concrete Paver Specifications



Installation Guidelines- Permeable Concrete Pavers

Full Exfiltration Cross Section

Allows storage and infiltration. This is a common cross-section installation over highly infiltratable soils such as clean sands and gravel mixtures. By design, all water seeps directly into the soil; a subbase drainage pipe system is not required.

Overflows are directed to swales, bioretention areas or storm sewer inlets.

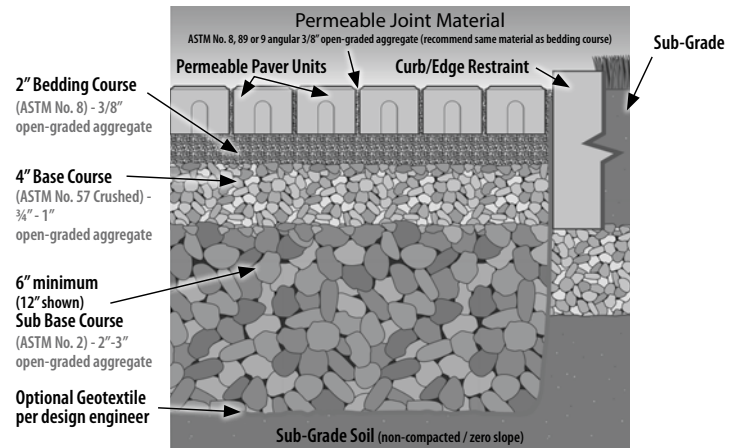

Partial Exfiltration Cross Section

Water does not infiltrate fully. A perforated pipe system in the subbase is required to allow the residual water to be evacuated to the storm water conveyance network.

Sub-grade soil preparation, including compaction, is part of the design/engineer's decision and should be executed according to the project specifications. If it is specified not to compact the subgrade, the initial undisturbed soil infiltration should be carefully maintained during excavation and construction; this will enable the base to drain as designed.

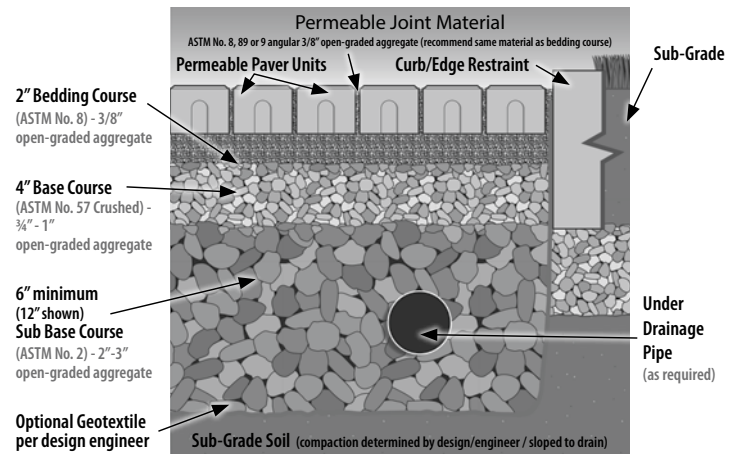

No Exfiltration Cross Section

Recommended when soil infiltration capacity is too low or the water table is too high. Water is discharged through a system of pipes and a flow restrictor to control the entry of water into the municipal network. The system essentially acts as an underground reservoir.

County Materials provides general construction guidelines to design professionals and installers of permeable interlocking concrete pavers systems. For additional installation information, reference the Interlocking Concrete Pavement Institute's (ICPI) Tech Spec Technical Bulletins: (<https://www.icpi.org/countymaterials>)

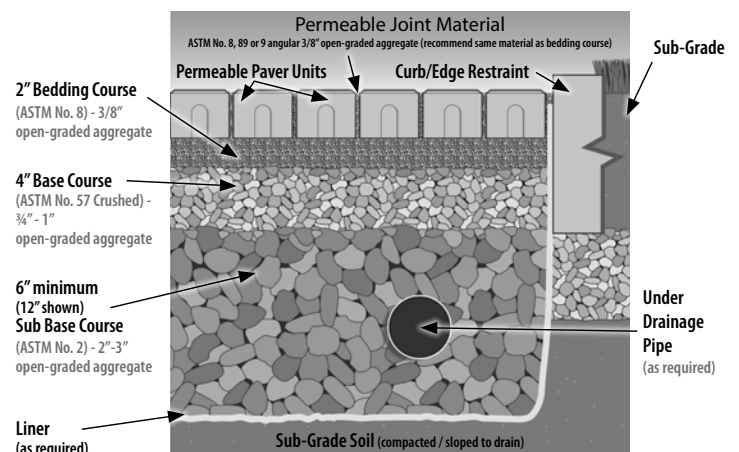

Cross Section Notes:

Geotextile fabrics may be required in some applications. Consult a civil or geotechnical (soil) engineer for recommendations.

Special design considerations should be considered for each application before starting, including but not limited to, traffic, drainage issues, climate, environmental conditions and functionality. A qualified engineer must perform a final design because site conditions and specific design parameters may vary.

Anyone using this material assumes any and all liability resulting from such use. The final determination of the suitability of any information or material for the use intended is the sole responsibility of the user.

Installation Guidelines- Permeable Concrete Pavers

1 Excavation

Excavate to the desired depth, based on the Engineer's analysis of the soil.

2 Curb

It is recommended to provide a concrete curb and/or a concrete curb and gutter for edge support around concrete permeable pavers.

3 Subbase and Base Materials

For the subbase, place the ASTM-33 #2 aggregate to a thickness not less than 6"; the thickness must be calculated by the engineer to allow storage of water based on the subsoil infiltration. State/Local regulations may have minimum requirements. Next, for the base place the ASTM-33 #57 aggregate to a 4" thickness and compact the aggregate.

4 Compaction

A buffer between the plate compactor and the paver surface is recommended to prevent scuffing. Refer to County Materials' Interlocking Concrete Paver or Slab Installation Guidelines, or contact County Materials for information. Vibrate in 4" lifts using a plate compactor or roller compactor for large areas to 98% Proctor Density.

5 Bedding Course

Once the subbase and base layers are compacted, the surface should be topped with a minimum 2" thick layer of ASTM-33 #8 aggregate for the bedding course that is screeded and leveled.

6 Deflectometer

Calculate stiffness-related parameters of an aggregate pavement structure.

7 Paver Installation

The concrete pavers should be placed immediately after the ASTM-33 #8 stone bedding course is placed and screeded. Install the pavers manually or with mechanical installation equipment. With mechanical installation, an installer is able to set between 10,000 – 13,800 sq. ft. per day with 1 operator.

8 Filling Paver Joints

Once all pavers are installed, disperse ASTM-33 #8, 9 or 89 open graded aggregate over the surface. This aggregate can be the same material used in the bedding course (ASTM-33 #8).

9 Clean Surface

Top up joints with joint material as needed and sweep the surface clean.

10 Final Compaction

After sweeping off excess stones from the surface, compact pavers into the bedding course with several passes of a plate compactor that has a buffer attached to prevent scuffing.

Additional aggregate may be placed in the joints as needed, and the surface swept clean.

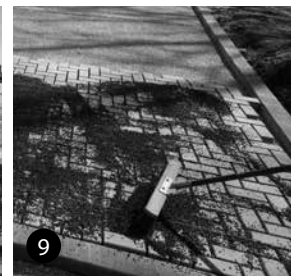

County Materials provides general construction guidelines to design professionals and installers of permeable interlocking concrete pavers systems. For additional installation information, reference the Interlocking Concrete Pavement Institute's (ICPI) Tech Spec Technical Bulletins: (<https://www.icpi.org/countymaterials>)

H₂O Pro® Pavers

Units & Sizes

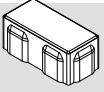
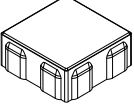
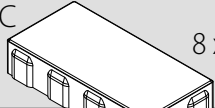
	D x H x L (Nominal Size) Inches • Millimeters	SF/Unit	Units/ SF	SF/ Layer	Layers/ Pallet	SF/ Pallet	Units/ Layer	Units/ Pallet	Lbs/ Pallet
A 	4 x 3 1/8 x 8 • 99 x 80 x 199	.22	4.5	11	8	88	50	400	3085
B 	8 x 3 1/8 x 8 • 199 x 80 x 199	.44	2.25	13.2	8	105.6	30	240	3695
C 	8 x 3 1/8 x 16 • 199 x 80 x 399	.89	1.13	13.2	8	105.6	15	120	3640

- Installed joint dimensions = 10 mm (²⁵/₆₄")
- Installed open area/layer = ±9.1% (depending on pattern)

Layer Configurations

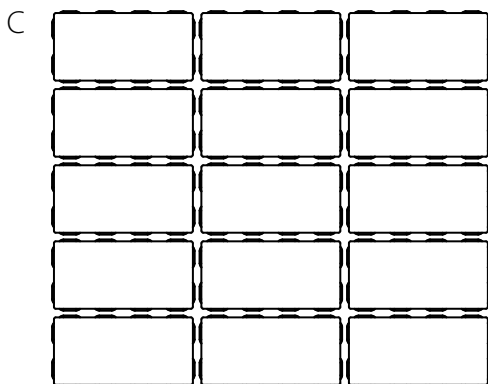
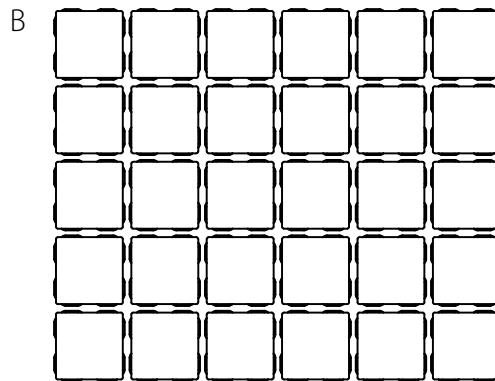
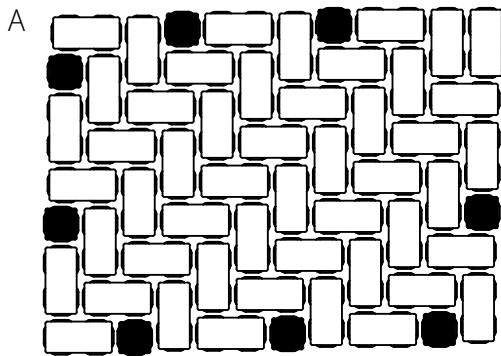

Note: The 4" x 8" size of H₂O Pro Pavers are manufactured in a herringbone layer pattern that easily accommodates mechanical installation. Units can also be installed in many different patterns by hand.

Note: (A) 4" x 8" layer pattern includes 4" x 4" pieces which are included for packaging purpose only and are not recommended for installation.

Installation Patterns

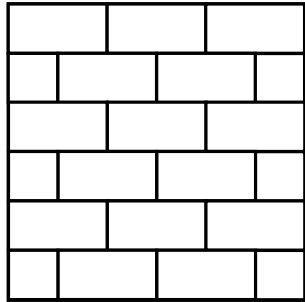

A or C Units Pattern #1

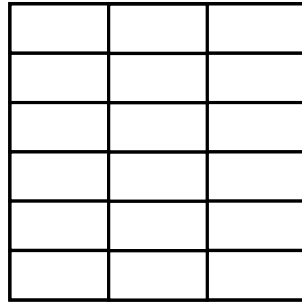

A or C Units Pattern #2

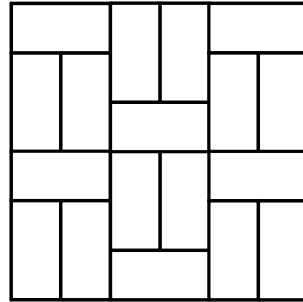

A or C Units Pattern #3

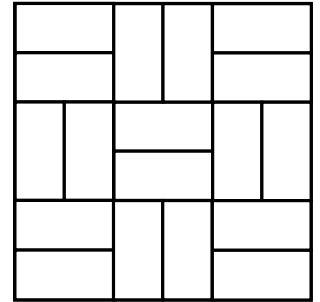

A or C Units Pattern #4

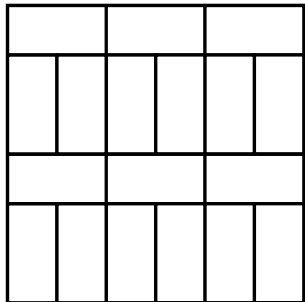

A or C Units Pattern #5

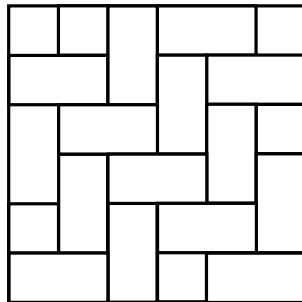

A or C Units Pattern #6

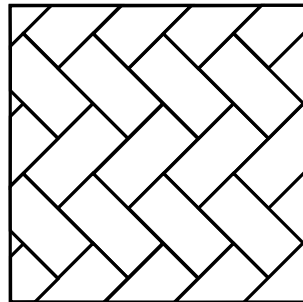

A or C Units Pattern #7

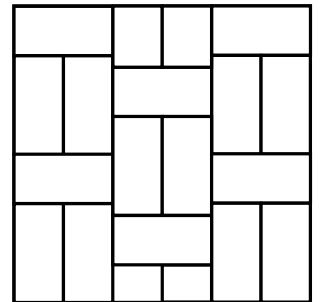

A or C Units Pattern #8

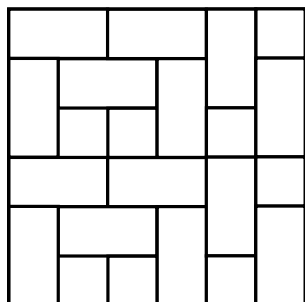

B or C Units Pattern #9

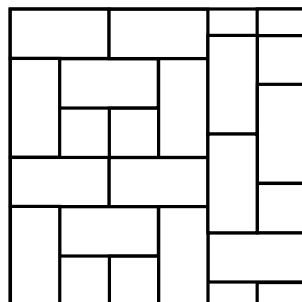

B or C Units Pattern #10

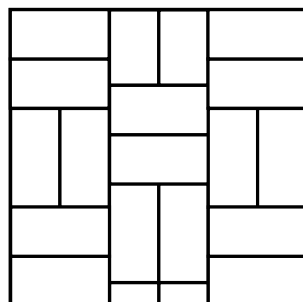

A or C Units Pattern #11

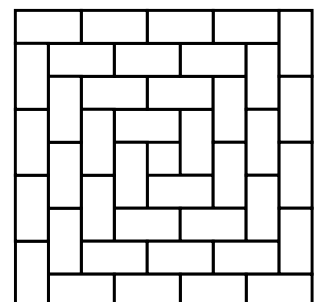

A or C Units Pattern #12

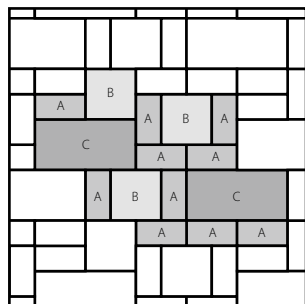

A, B & C Units #13
A-42% B-25% C-33%

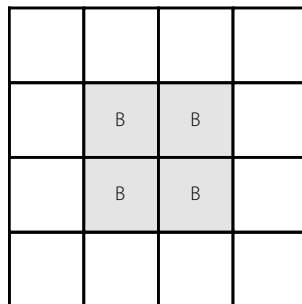

B Units #14

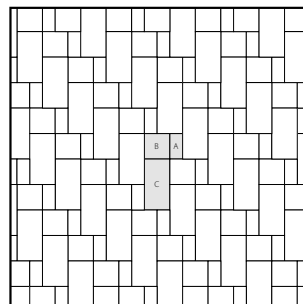

A, B & C Units Pattern #15
A-17% B-29% C-57%

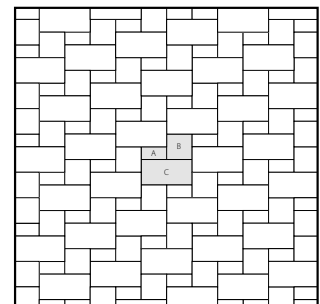

A, B & C Units Pattern #16
A-14% B-29% C-57%

Installation Patterns

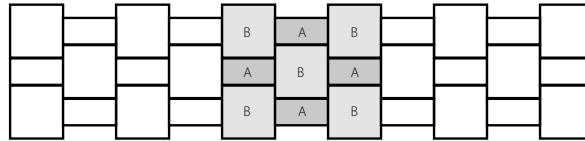

A & B Units #17
A-29% B-71%

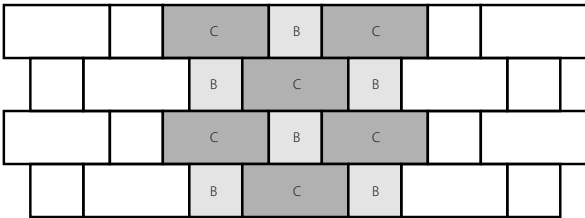

B & C Units #18
B-33% C-67%

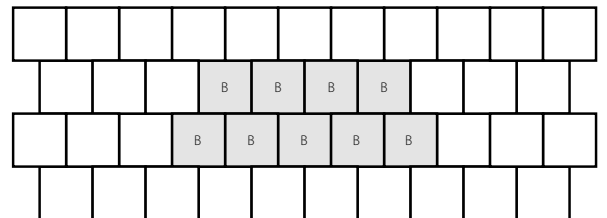

B Units #19



H₂O Pro® Pavers



NEW for 2021!

Rejuvenate™ Permeable Pavers

Units & Sizes

D x H x L (Nominal Size)
Inches • Millimeters

5 x 3½ x 10 • 127 x 80 x 254

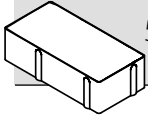

SF/ Unit	Units/ SF	SF/ Layer	Layers/ Pallet	SF/ Pallet	Units/ Layer	Units/ Pallet	Lbs/ Pallet
.31	3.23	9.64	8	77.12	28 Full, 7 Halves	224 Full, 56 Halves	3100

- Installed joint dimensions = 11 mm (.433")
- Installed open area/layer = 1.28 SF per layer

Layer Configuration

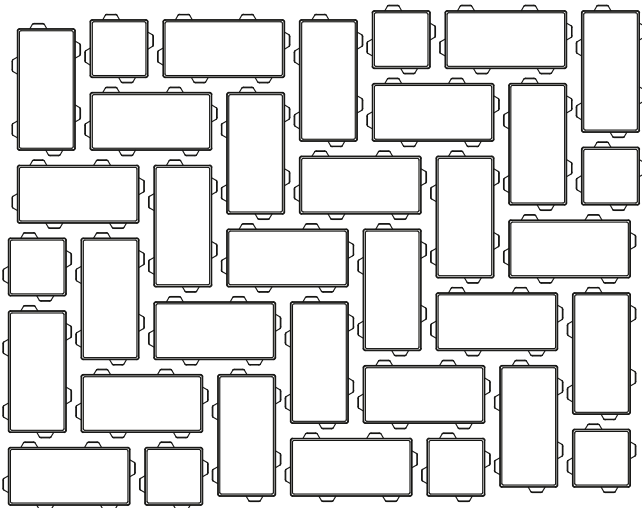

NEW for 2021!

Rejuvenate™ Permeable Pavers

Installation Pattern

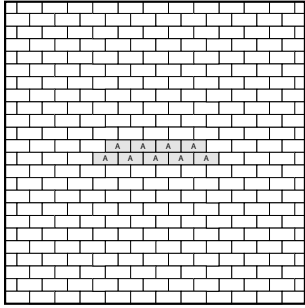

Running Bond

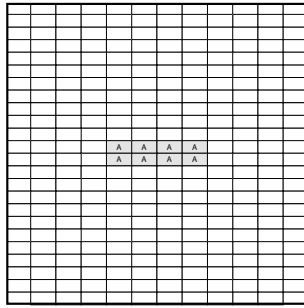

Stack Bond

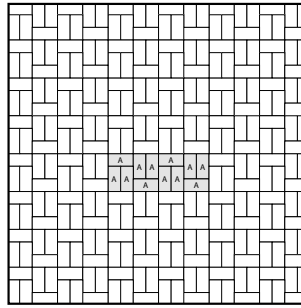

Single Basket Weave

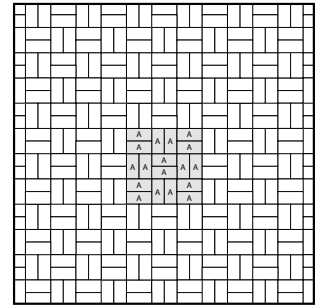

Parquet/Basket Weave

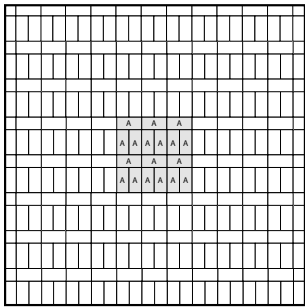

Stack Bond (Variant)

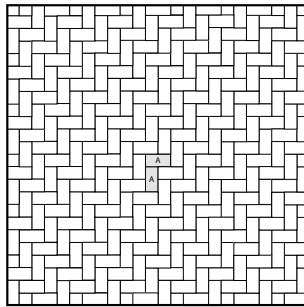

90° Herringbone

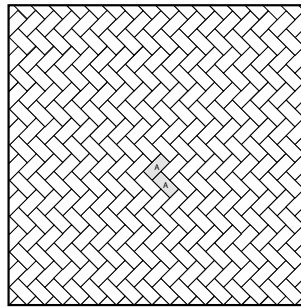

45° Herringbone

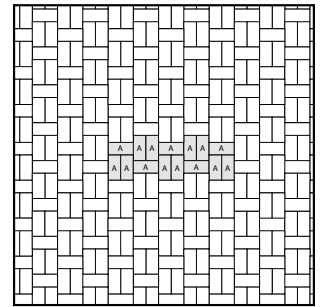

Single Offset Basket Weave

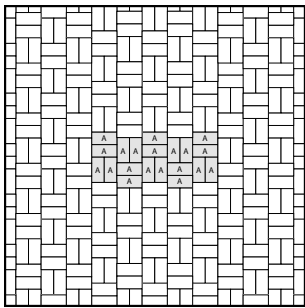

Double Offset Basket Weave

Harmony™ Permeable Pavers

This product appears in the Commercial Landscape Applications Catalog

Units & Sizes

D x H x L (Nominal Size)
Inches • Millimeters

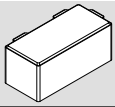
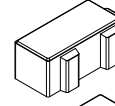
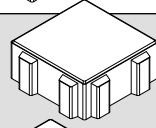
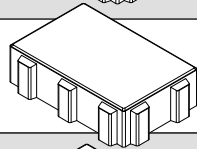
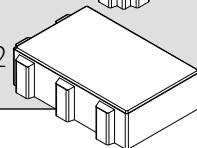
A1		4 x 3 1/8 x 8 • 102 x 80 x 203
A2		4 x 3 1/8 x 8 • 102 x 80 x 203
B		8 x 3 1/8 x 8 • 203 x 80 x 203
C1		8 x 3 1/8 x 12 • 203 x 80 x 305
C2		8 x 3 1/8 x 12 • 203 x 80 x 305

SF/Layer	Layers/Pallet	SF/Pallet	Lbs./Pallet
11.51	8	92.08	3170

Note: Harmony Permeable Pavers are special order only.

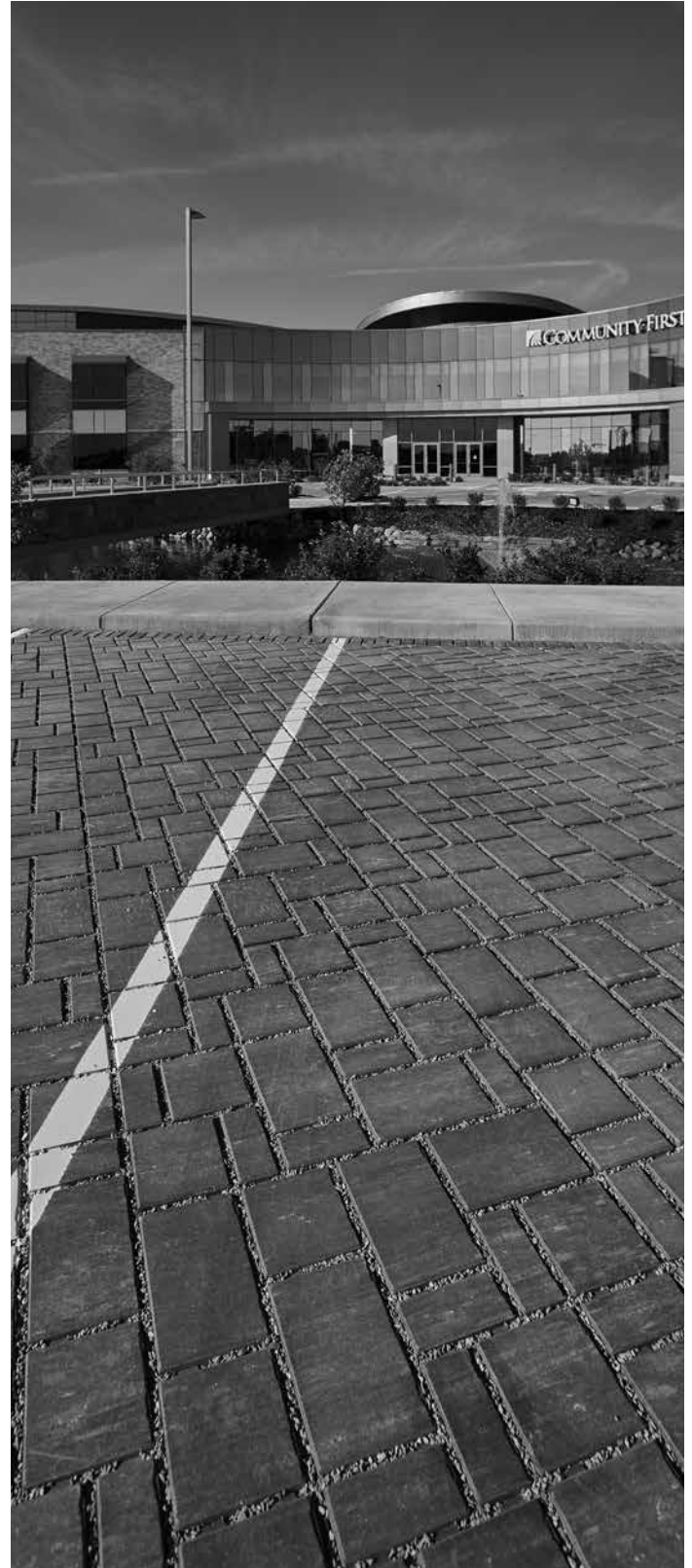

Layer Configuration

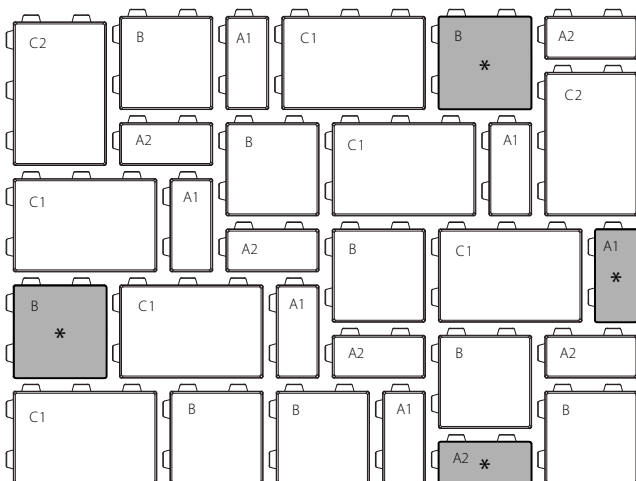

Installation Pattern

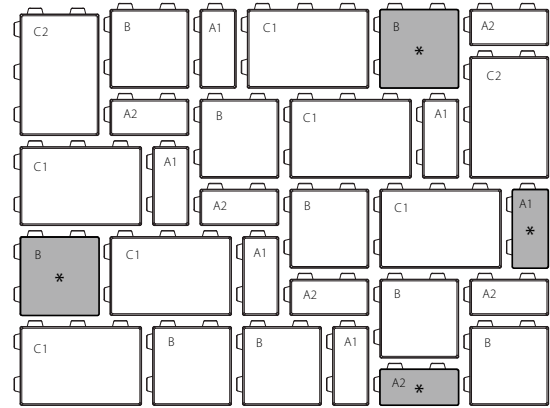
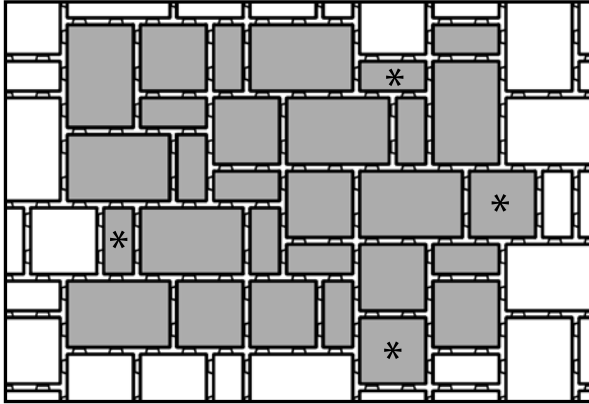

- Installed joint dimensions = 15mm (19/32")
- Installed open area/layer = $\pm 10.6\%$

Note: In machine-laid applications, the shaded pavers shown left are designed to be interchangeable to allow for stitching of the pattern as indicated in the diagram at right. Harmony units are manufactured to create a three piece pattern, mechanically installed by pallet layer. Schematic above illustrates paver sizes/orientation on the layer.

Can be used in conjunction with H₂O Pro Pavers to meet ADA compliance.



Units & Sizes

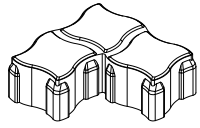

D x H x L (Nominal Size)
Inches • Millimeters

Permeable

8⁵/₈ x 3¹/₈ x 8⁵/₈ • 219 x 80 x 219

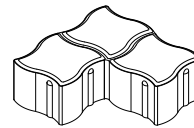

D x H x L (Nominal Size)
Inches • Millimeters

Sandset

8⁵/₈ x 3¹/₈ x 8⁵/₈ • 219 x 80 x 219

SF/ Unit	Units/ SF	SF/ Layer	Layers/ Pallet	SF/ Pallet	Units/ Layer	Units/ Pallet	Lbs/ Pallet
.4	2.5	10	8	80	25	200	2850

SF/ Unit	Units/ SF	SF/ Layer	Layers/ Pallet	SF/ Pallet	Units/ Layer	Units/ Pallet	Lbs/ Pallet
.4	2.5	10	8	80	25	200	3000

Layer Configurations

Renewable Pavers Permeable Layer Pattern

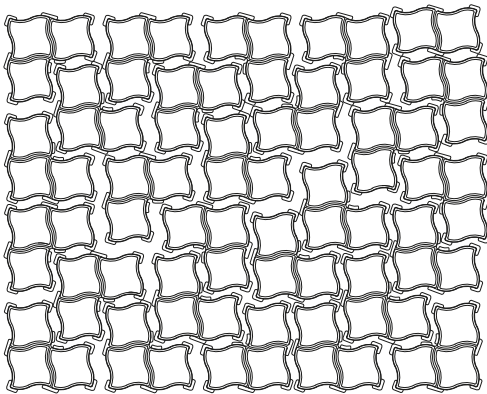

- Installed joint dimensions (Permeable) = 10 mm (²⁵/₆₄")
- Installed open area/layer = ±7.1%

Renewable Pavers Sandset Layer Pattern

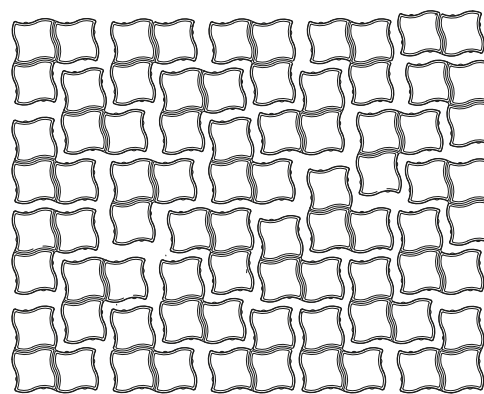

- Installed joint dimensions (non-permeable or sandset) = 2mm (1/16")

Note: Textured paver and patio stone surfaces require a buffer between the plate compactor and the paver surface to prevent scuffing. Refer to County Materials' Interlocking Concrete Paver or Slab Installation Guidelines, or contact County Materials for information.





Retaining Walls, Garden Walls, Seat Walls & Step Units Specifications



Installation Guidelines- Retaining Wall Systems

Site Analysis

Your retaining wall design must begin with a proper site analysis. The conditions at the site will determine your wall height and location, as well as reinforcement requirements. Check the soil type and conditions at the base of your wall for adequate bearing pressure. The soil below a wall needs to be strong enough to support the weight of the wall resting on it. If the soil is in a moist or wet condition, extra precautions may be required to provide a stable base. An accurate site plan must also include the location of all lot lines, utilities, buildings, driveways and parking areas. Note any permanent trees or vegetation. Prior to design, proper permits, owner approvals, utility clearances* and temporary easements must be obtained.

If your jobsite has any of the following conditions, get a complete engineering analysis from a qualified designer before proceeding:

- Soft or unstable soils
- Excessive water runoff
- Surcharges greater than a residential driveway
- Waterfront and shoreline sites
- Terraces
- Slopes greater than 3 to 1 above or below the wall
- Wall heights exceeding 4'

Finalize Design

Develop a wall layout that will maximize drainage and direct the flow of water around the wall and away from buildings. Consider material and equipment access at the site, and try to minimize the excavation and hauling of soil and fill.

Reference the NCMA for more information.

Typical Reinforced Wall Application

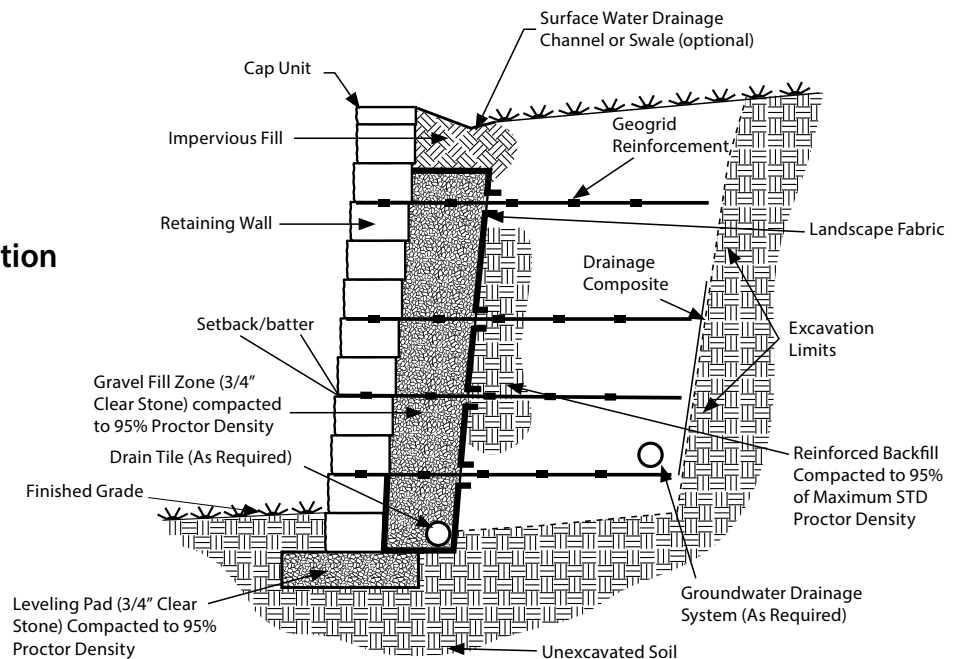

Installation Guidelines- Retaining Wall Systems

Getting Started

Build on stable, well-compacted ground. Spend extra care and preparation on the base and bottom row of your wall. Any unevenness in the base course will be amplified and difficult to correct after several courses have been installed. Always begin your wall construction at the lowest possible point of your base and step up. You should also begin from the corner blocks of steps and work outward to the end of the wall.

Leveling Pad

Excavate a shallow trench at the base of your planned wall. It should be a minimum of 24" wide and 8" deep to accommodate the leveling pad material and required unit embedment below grade. Place a minimum of 6" of base material in the leveling pad layer. Base material should consist of either granular, well-drained coarse sand, angular gravel or crushed stone. Use a hand-operated plate compactor to compact the base material every 2" to achieve a solid and level foundation. The leveling pad may be stepped in 8" increments to match any grade changes along the front of the wall.

Unit Installation

Place retaining wall units side-by-side in the center of the leveling pad (Figure 1). Align and level each unit with adjacent ones side-to-side and front-to-rear. Carefully tap high points with a rubber mallet. A thin layer of sand (1" or less) may be used on top of the compacted base material to help level the first course. Always align from the back of units, not from irregular front faces. A string line and level will keep each new row of blocks on track.

After placing and leveling the first course, install drain tile behind the block as necessary. If applicable, fill voids in and between block and a minimum of 12" behind block with clean granular drainage rock. Replace enough fill in front of the base course to secure it. Fill behind block with drainage rock until it is level with the top of the first course. Compact the fill with a hand-operated plate compactor on both sides of the first course to required specifications, or to 95% of maximum Standard Proctor Density (a method used to determine compaction). Compact on top of the block, and clean the top of the first course units to begin installation of second course.

Unit Embedment

Generally, if the grade in front of the wall is level, one half of the first course should be embedded below grade. Embedment should be increased for special conditions such as slope, soft foundation soils or shoreline applications. As a general rule, the first course of block should be embedded at a 6" minimum. For walls that are 4' or higher, add 1" embedment per one-foot rise.

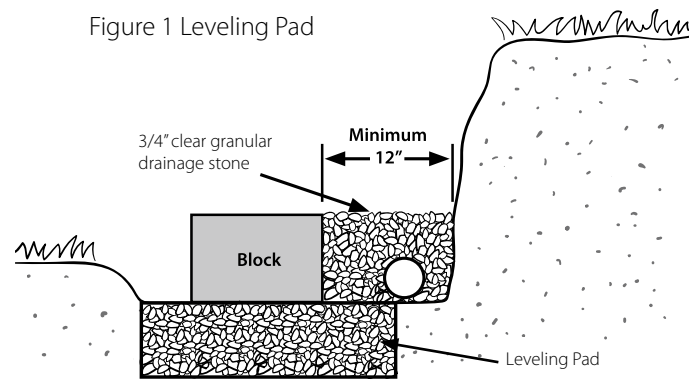

Note: This guide offers typical installation recommendations for retaining walls under 4' high. For retaining wall installations over 4' high, and for walls that will be installed in wet or unstable soils, in areas with heavy surcharges, or applications that require drainage or other special conditions, a final design must be performed by a qualified engineer; site conditions and specific design parameters may vary. If you have questions, take time and ask a qualified contractor or your retaining wall distributor for more information.

Standard Proctor Density is referred to several times in this guide. Proper placement and compaction of soils is essential to the successful performance of any retaining wall system. Reinforced soil structures routinely specify that all soils be compacted to 95% maximum density as determined by ASTM D698-Standard Proctor Density. Post construction settlement is an obvious concern of poorly compacted materials, excessive lateral wall movement and/or insufficient shear strength. Soils must be compacted in lifts to achieve maximum soil shear strength and validate the design.

*Call Diggers Hotline in advance (800-242-8511) before digging to locate any underground lines.

Installation Guidelines- Retaining Wall Systems

Additional Courses

Install additional courses with seams of each successive course offset by several inches from the units below for structural stability.

County Block and Tribute retaining walls with pins:

For the second and additional courses, set each unit 1" back from its finished position. Insert two pins in the front holes, and pull blocks forward so pins are fully seated into slots in two separate units below, locking them together. County Block Jumbo units only require 2 pins per block; these may be placed in any 2 of the 3 available holes. It may be necessary to tap pins lightly with a hammer for proper alignment. Check each course for tightness of each unit with adjacent units and check wall alignment.

Winston and Integrity retaining walls without pins:

If your wall system does not require the use of pins or cube system, be sure that the lower units are clean and additional courses are properly locked in place with the built in concrete locking mechanism.

Drain Tile

Drain tile should be placed behind the wall and extruded wherever possible. This means the drain tile may have to be extruded through the face of the wall (Figure 2) or at the end of the wall (Figure 3).

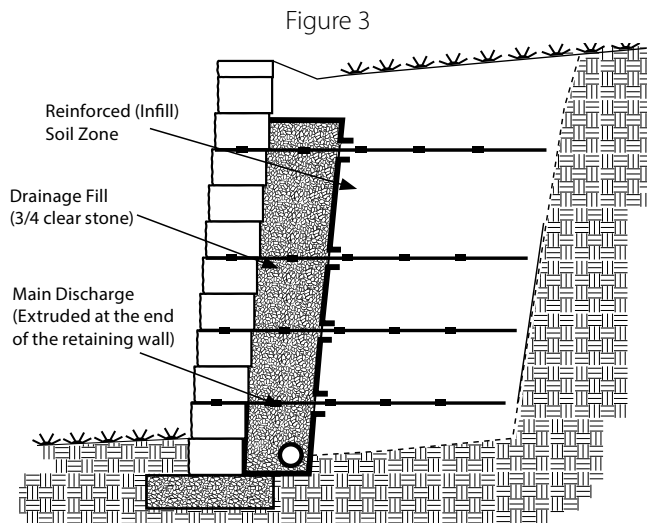
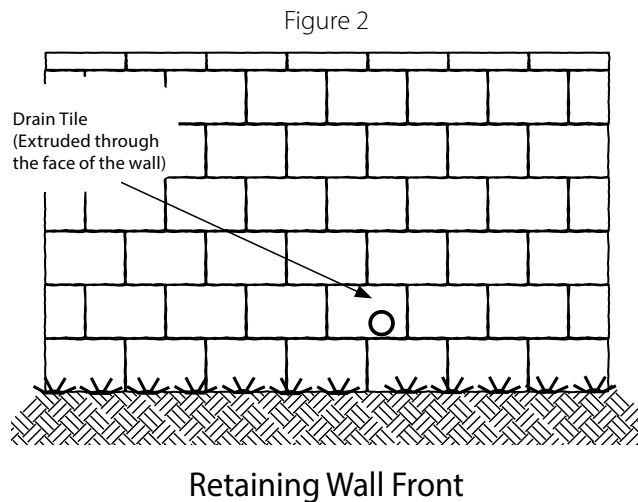

Installation Guidelines- Retaining Wall Systems

Backfilling and Compaction

After each course is aligned, if applicable, fill in block cores and voids between units with drainage rock. Then, backfill and compact each course as you continue constructing the wall. Make sure to backfill in front of the wall until the desired grade is achieved (Figure 4). Next, use a hand-operated plate compactor directly over the top of the block to consolidate aggregates and pulverize any residual concrete fragments (slag). When compacting, it is important to backfill in small lifts. Know your compactor and how much it can handle. Most small compactors can handle a 6" lift at a time. This is a good general rule to follow when using a compactor. Work from the back of the wall to the furthest edge of excavated area, with a three to five foot minimum compacted zone, until all materials are compacted.

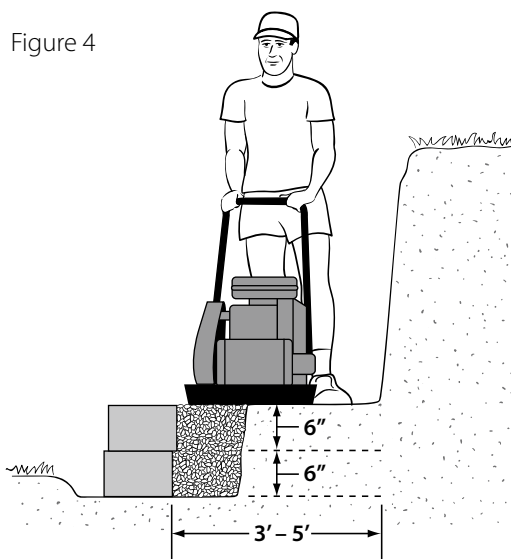

Retaining walls require only a certain amount of compaction with hand-operated equipment to consolidate the soil and minimize settling. Excessive compaction can cause forward rotation of the wall facing. Large equipment operating too close to the wall may cause over-compaction and result in localized bulging. It can also damage geogrid reinforcement materials.

Geogrid Reinforcement

If geogrid reinforcement is required, excavate behind wall location for a distance equal to the designed embedment length of the grid. Construct the wall up to the designated height of first grid layer. Place and compact granular fill within and behind the wall. Backfill and compact soil behind the granular fill in the reinforced zone.

Lay geogrid, cut to appropriate sizes and with the strength direction perpendicular to the wall, on top of units. The cut ends should nearly touch the front edge of the units but not extend past the front face. Extend the grid pieces to the back of the slope. Place the next course of units on top of the geogrid and be sure the units are locked in place by pins (if applicable) or the concrete locking mechanism. Pull units forward, making sure they are secure. Place granular drainage rock in cores (if applicable) between block and 1' behind units. Pull geogrid taut – staking is recommended – before placing backfill material. Compact backfill in 6" lifts behind wall.

*Estimation Geogrid Charts can be found on County Materials' website at www.countymaterials.com. Simply go to Downloads / Product Installation & Maintenance Guides / Landscaping. There you will find HTS Manuals specific to County Block®, Integrity™, Rib Rock™ and Tribute®.

Installation Guidelines- Retaining Wall Systems

Ending and Capping a Retaining Wall

End a retaining wall by either stepping the courses or rolling the wall into the existing embankment. As a general rule, 2' of block buried into the hillside will prevent potential erosion. Complete your wall with available cap units placed flush with the face, set back slightly or set out as much as 1". Cap units should be installed by starting on one end of the wall, not in the middle. Use retaining wall adhesive on all cap units to hold them in place. Cap units may need to be split or cut for a proper fit (Figure 5).

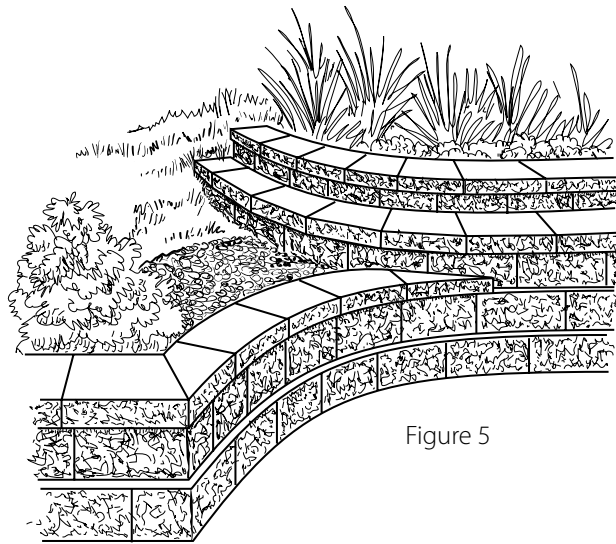

Figure 5

Inside Corners

Lay a unit perpendicular to the end of the wall so its side face is flush with the back of the first course. Complete the first course. On each successive row, alternate the position of units over the right angle to obtain an interlocking corner (Figure 6). For retaining wall systems with concrete locking mechanisms, make sure to cut or chisel off the locking mechanism to achieve the proper overlap.

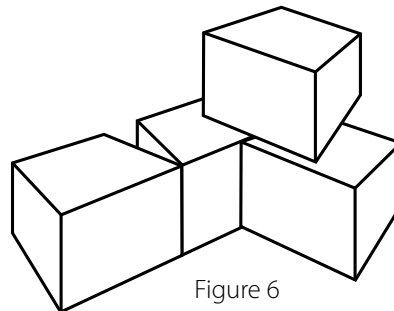

Figure 6

Installation Guidelines- Retaining Wall Systems

Curves

Simply fan or bring the tails of units together to make convex (outside), concave (inside) and serpentine curves (Figure 7).

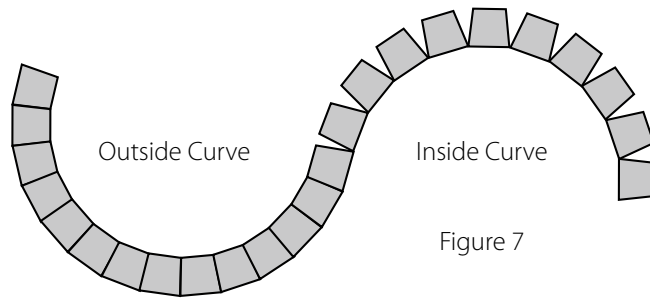

Figure 7

Tribute retaining walls with curves:

The Tribute retaining wall system can create 4' radius curves with no cutting of units.

Outside Corners

County Block, Tribute, Integrity and Winston retaining walls with outside corners:

The units must be split in half to create an outside corner. Each unit split will create 2-corner block (one left, and one right corner). On each successive row, alternate the position of the cut corner units over the right angle to obtain an interlocking corner. Install additional courses with seams of each successive course offset by several inches from the units below for structural stability (Figure 8). Use retaining wall adhesive to help secure each corner unit.

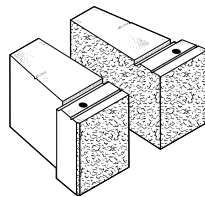

County Block

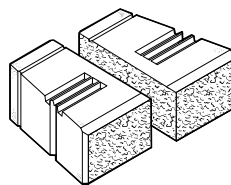

Tribute

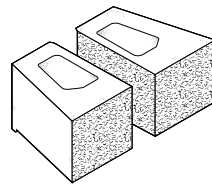

Integrity

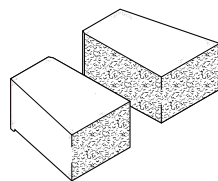

Winston (Straight)

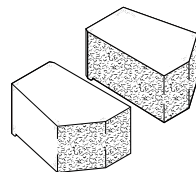

Winston (Tri-split)

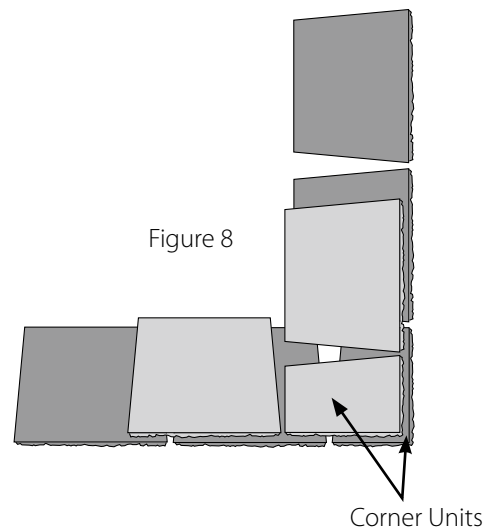

Figure 8

Care & Maintenance- Garden and Retaining Walls

Color Selection

Colors shown may vary from actual hues and should only be used as a guide. Refer to actual product samples for final color selection. Because concrete products are manufactured with high quality, naturally-mined aggregates and materials, variations in color or shading should be expected in products that are manufactured at different times and in units having different shapes. This color or shading variation is acceptable in the industry. County Materials recommends immediately verifying the product and color upon receipt, and prior to opening pallets. For any discrepancies, contact your local County Materials representative before installation. Use of product constitutes acceptance.

Proper Color Distribution and Installation Techniques

Color of concrete products may vary significantly between production lots. Install concrete units from several pallets to ensure distribution of color. The contractor must install concrete units in accordance with the landscape industry's best practices according to ICPI and NCMA Standard Specifications and the manufacturer's instructions. County Materials is not liable or responsible for loss or damage resulting from improper use, handling or failure to follow installation instructions. Follow all applicable warnings, advisories, and instructions.

Efflorescence

Efflorescence is a naturally occurring process in all concrete products which may appear in the form of a white powdery film on the unit's surface. Efflorescence may be more perceivable in darker colors. It does not, in any way, compromise the functionality or the structural integrity of the product or your installation. Although efflorescence cannot be prevented, it will wash off over time or it can be cleaned with an industry cleaner. County Materials accepts no responsibility or liability for the occurrence of efflorescence.

Washing Guidelines

Seasonal maintenance is recommended for all County Materials' landscape products. General washing guidelines are provided for the following: organic stains, including fruit, soil and leaf residue, algae and moss stains, and efflorescence. For efflorescence stains, wash with a hose and stiff broom.

Cleaning Agents

Concrete cleaning agents are not required but are an option for all County Materials' retaining wall units. There are many different cleaning agents specific to application requirements and desired results. Use of the cleaning agent must comply with all instructions provided by the cleaning agent manufacturer, and the cleaning agent method must be performed on a separate mock-up sample not less than 7 feet by 7 feet prior to Buyer approval. County Materials accepts no responsibility or liability for the use of cleaning agents on our retaining wall units.

Construction Residue

A possible by-product of cutting concrete units during installation with a saw is residue-filled water or concrete dust. Residue-filled water or re-hydrated dust can cling to the surface of units and leave a concrete stain. It is recommended to wash and remove the water or concrete dust from the surface of the garden and retaining walls before it dries. Construction residue can also happen through soil disturbance or environmental elements. These contaminants should be removed immediately; they do not compromise the functionality or the structural integrity of the product or your installation. County Materials accepts no responsibility or liability for the occurrence of construction residue or concrete stains.

Care & Maintenance- Garden and Retaining Walls

Sealing

Concrete wall sealers, though not required, may minimize damage from deicing chemicals, prevent staining and enhance the color. If you choose to use a sealer, it is recommended to use a penetrating sealer which is breathable. Consult a County Materials' sales representative for complete sealing instructions. County Materials Corporation accepts no responsibility or liability for the use of sealing agents on our Garden and Retaining Walls.

Delivery & Storage

Buyer(s) of retaining wall systems manufactured by County Materials Corporation shall inspect the material within 48 hours of receipt (the "Inspection Period") to ensure that the style, color, etc., comply with the specifications, and that the material is not damaged or defective. The buyer(s) will be deemed to have accepted the material unless it notifies County Materials Corporation in writing of any non-conforming material during the Inspection Period and furnishes such written evidence or other documentation as required by County Materials Corporation. Material that does not meet the specifications, is defective, or is damaged should not be used for construction.

Once the material is delivered, the buyer(s) is solely responsible for protecting the material from damage, including from snow, excessive mud, wet concrete or any agent that will bond to or damage the material. County Materials Corporation is not responsible for any damage to the material that occurs after delivery.

For Reference Only – Landscape Products Specifications Guide

This Guide, provided at no cost by County Materials Corporation, is intended to serve only as an informational resource for buyer(s) of retaining wall systems manufactured by County Materials Corporation. Every effort has been made to ensure the accuracy of the information presented in this Guide. However, this Guide is provided for reference only and is not a substitute for and does not replace the need for registered professional engineering design and experienced contractor installation. Actual site conditions may vary significantly from those presented in the estimating tables herein. County Materials Corporation strongly urges buyer(s) to exercise diligence and care in the selection, design, installation and use of any construction materials. Review Tech Data Sheets, Care and Maintenance, ICPI and NCMA industry association best practice instructions before starting and/or Buyer approval of Landscape projects. The final determination of the suitability of any information contained in this Installation Guide is the sole responsibility of material buyer(s).

DISCLAIMER OF LIABILITY

COUNTY MATERIALS CORPORATION DISCLAIMS ANY AND ALL LIABILITY FOR DAMAGES OR LOSSES OF ANY KIND OR NATURE TO PERSON(S) OR PROPERTY, INCLUDING, BUT NOT LIMITED TO, DIRECT, INDIRECT, INCIDENTAL, CONSEQUENTIAL OR PUNITIVE DAMAGES, ATTORNEYS' FEES OR COSTS, ARISING OUT OF OR RELATED TO THE USE OF THIS INSTALLATION GUIDE, INCLUDING, BUT NOT LIMITED TO ANY WORK THAT MAY BE PERFORMED BY ANY CONTRACTORS OR INSTALLERS.

WAIVER OF CLAIMS AND AGREEMENT TO HOLD HARMLESS

BY USING THIS INSTALLATION GUIDE, YOU AGREE TO WAIVE ANY AND ALL CLAIMS AGAINST COUNTY MATERIALS CORPORATION, ITS OFFICERS, DIRECTORS, EMPLOYEES, VOLUNTEERS, REPRESENTATIVES, AND AFFILIATES, AND HOLD THEM HARMLESS FOR ANY DAMAGES OR LOSSES OF ANY KIND TO PERSON(S) OR PROPERTY, INCLUDING, BUT NOT LIMITED TO, DIRECT, INDIRECT, INCIDENTAL, CONSEQUENTIAL OR PUNITIVE DAMAGES ARISING OUT OF OR RELATED TO THE USE OF THIS INSTALLATION GUIDE, INCLUDING BUT NOT LIMITED TO THE SELECTION, DESIGN, INSTALLATION OR USE OF ANY MATERIALS, PRODUCTS, STRUCTURES, COMPONENTS OR ASSEMBLIES.

Purchaser is responsible for proper use, handling, maintenance and installation of product as determined by the manufacturer and industry standards. Product has a fitness for a particular purpose. Use and/or application of product not intended by the manufacturer and not in compliance with industry standards is not recommended. Use and/or installation and application are the sole responsibility of the purchaser.

Tribute® Retaining Wall System

Units & Sizes

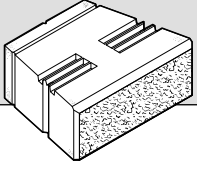
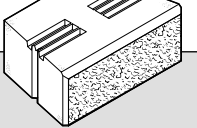
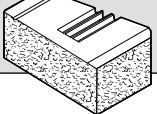
Splitface * SRW	D x H x L (Nominal Size) Inches • Millimeters	SF/ Unit	Units/ Pallet	Lbs/ Unit	Lbs/ Pallet
	12 x 6 x 16 • 305 x 152 x 406	.67	36	75	2750
	10 x 6 x 16 • 254 x 152 x 406	.67	36	63	2313
	12 x 6 x 8 • 305 x 152 x 203	Face - .33 Return - .5 Total Unit - .83	72	37	2750

* SRW (Segmental Retaining Wall Unit)
* FSW (Free Standing Wall Unit)

• Rustic texture products are available in all colors (Made to Order).

• Calculate the number of Tribute full units needed: SF x 1.5

Wall Configurations

Tribute retaining walls with pins:

Each Tribute unit has a unique three-position pin placement system. Two pins per unit secure Tribute block in place.

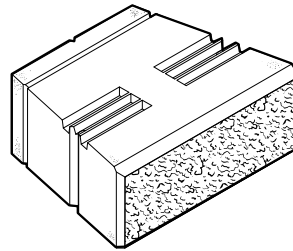

• Tribute Two-sided Vertical Face Seat Wall Installation

It is recommended that all seat walls have the first course buried for embedment. Starting on the second and succeeding courses, position all Tribute units with the pinholes over the middle-receiving channel. This will lock the units in a vertical position. Seat walls should not exceed a height of 36".

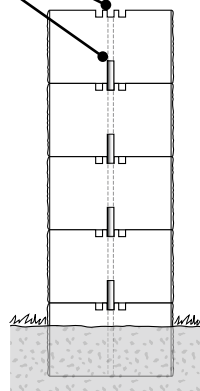

• Tribute Two-sided Recessed Face Seat Wall Installation

Place every course on the opposite receiving channel than the previous. This will give your Tribute Retaining Wall System a three dimensional look.

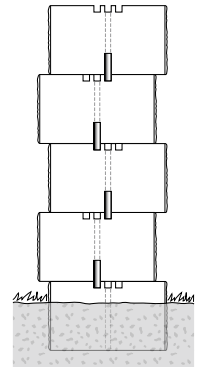

• Tribute Set Back Retaining Wall Installation

Position pinholes of each successive Tribute unit over the rear-receiving channel on the lower unit. This placement will give your Tribute wall an approximate 7° set back.

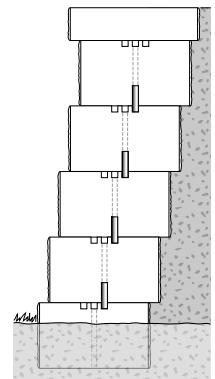

Tribute® Retaining Wall System

Seat Wall and Column Design

Finished Ends and Corners on Tribute Two-sided Seat Wall Installations

To finish your free standing seat wall on each end, split 2" off the back of each unit at the indicated grooves for a two-sided split appearance on the front and back faces. Then split the unit in half (front to back) at the indicated center notch to achieve two half blocks with three split sides. At your desired seat wall starting point, place one half block with a split surface facing out (Figure 2). Next install full units side-by-side for the length of the seat wall. End the course by placing another half block with a split surface facing out.

Second course: Split another two sided Tribute unit in half as before. On one half block, measure and mark the width of one face at 2-7/8". On the other split face, measure and mark its width at 4-7/8". Draw a line between each marked face and saw the unit along the appropriate angle to create a specially cut two-sided 1/4 return unit. Place one sawed 1/4 piece, split surface out, on the end of the first course to start the second course. Make sure the cut angle of this second course unit is opposite of the angle in the first course for proper bond. Use retaining wall adhesive to hold all end pieces securely in place. Continue laying standard units side-by-side, and install the other 1/4 return unit at the end of the seat wall following the same instructions.

Continue building successive courses by repeating instructions above, alternating each 1/4 return end unit and using adhesive for proper stability. When the seat wall is finished to the proper height, adhere caps for a finished effect.

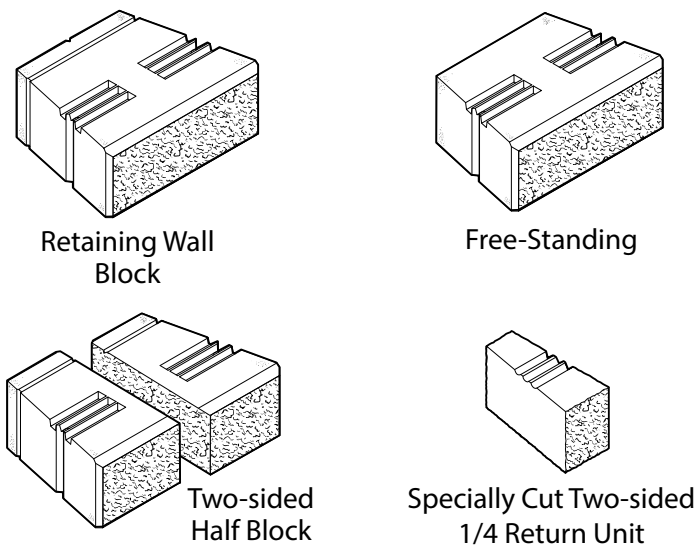
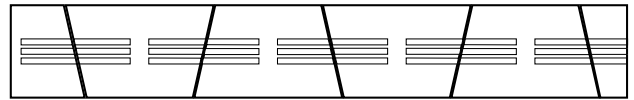
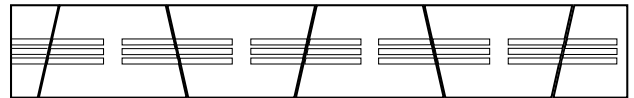

Figure 2 Tribute Two-sided Seat Wall



Courses 1,3,5...



Courses 2,4,6...

Constructing Columns and Pillars with Tribute units:

Split Tribute units in half (as shown). Place four half units per course in alternating running bond pattern. Apply concrete adhesive between each course as you construct the pillar. The hollow area inside a pillar can accommodate electrical conduit for a light or a wood 4" x 4" post to support a trellis, light or garden gate.

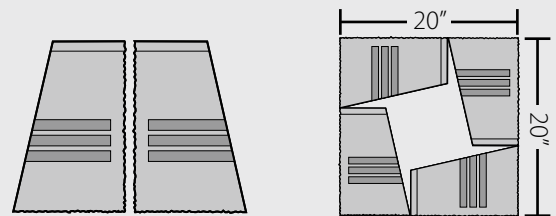

Integrity™ Retaining Wall System

Units & Sizes

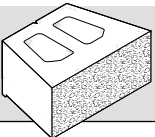
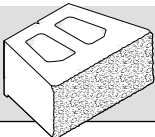
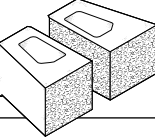
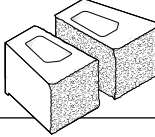
Splitface	Rustic	D X H X L (Nominal Size) Inches • Millimeters	SF/ Unit	Units/ Pallet	Lbs/ Unit	Lbs/ Pallet
		12 x 8 x 18 • 305 x 203 x 457 Standard	1	36	80	2925
		12 x 8 x 9 • 305 x 203 x 228 Standard Corner	Face - .5 Return - .66 Total Unit - 1.16	72	40	2925



Winston® Retaining Wall System

Units & Sizes

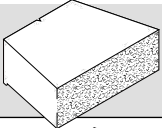
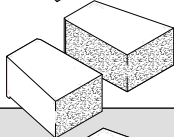
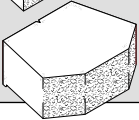
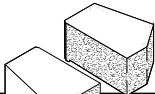
	D x H x L (Nominal Size) Inches • Millimeters	SF/ Unit	Units/ Pallet	Lbs/ Unit	Lbs/ Pallet
	12 x 6 x 17½ • 305 x 152 x 445 Straight	.73	45	73	3340
	12 x 6 x 8¾ • 305 x 152 x 222 Straight Corner	Face - .36 Return - .5 Total Unit - .86	90	36	3340
	12 x 6 x 16 • 305 x 152 x 406 Tri-Split	.67	45	65	2975
	12 x 6 x 8 • 305 x 152 x 203 Tri-Split Corner	Face - .36 Return - .5 Total Unit - .86	90	31	2790

Note: Winston unit lip is 1" deep.

*This product is only available in select markets. Contact your County Materials' representative for details.



County Block® Retaining Wall System

Units & Sizes

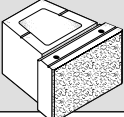
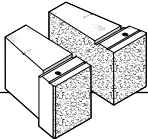
Splitface	D x H x L (Nominal Size) Inches • Millimeters	SF/ Unit	Units/ Pallet	Lbs/ Unit	Lbs/ Pallet
	12 x 7 ⁵ / ₈ x 12 ¹ / ₂ • 305 x 194 x 318	.66	64	46	2965
	12 x 7 ⁵ / ₈ x 6 ¹ / ₄ • 305 x 194 x 159 Corner	.33	128	32	4141

- Calculate the number of:
 - County Block Standard units needed: SF x 1.5
- Calculate the equal number of both sizes blended into a County Block wall: SF divided by 1.61



County Cub® Landscape Units

Units & Sizes

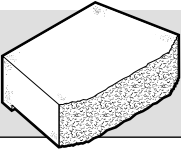
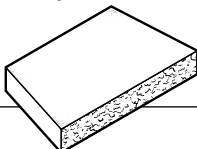
	D x H x L (Nominal Size) Inches • Millimeters	SF/ Unit	Units/ Pallet	Lbs/ Unit	Lbs/ Pallet
	8 x 3 ⁵ / ₈ x 12 • 203 x 92 x 305 Standard	.30	168	22	3750
	8 x 2 x 13 ³ / ₈ • 203 x 51 x 340	-	108	16	1773

• Calculate the number of County Cub units needed: SF x 3.3



Rib Rock™ Landscape Block

Units & Sizes

Available in Rough or Dry Stack Textures	D x H x L (Nominal Size) Inches	Face SF/Unit	Units/ Pallet	Approx. Lbs/Unit	Lbs/ Pallet
1 - 6" PVC Drain Block	23 x 24 x 48	8	2	1800	3645
2 - 48" Regular Block	23 x 24 x 48	8	2	1800	3645
3 - 44" Short Key Block	23 x 24 x 44	7.32	2	1750	3545
4 - 52" Long Key Block	23 x 24 x 52	8.66	2	2200	4445
5 - Base Block (No Channel)	27 x 24 x 48	8	2	2800	5645
6 - 1/2 Block	23 x 24 x 24	4	2	1100	2245
7 - Half Corner Block Left	23 x 24 x 24	8	2	1200	2445
8 - Half Corner Block Right	23 x 24 x 24	8	2	1200	2445
9 - Full Corner Block Left	27½ x 24 x 52	12	2	2320	4685
10 - Full Corner Block Right	27½ x 24 x 52	12	2	2320	4685
11 - Regular Cap	25 x 7 x 48	2.33	4	440	1805
12 - Corner Cap Left	25 x 7 x 48	2.33	4	440	1805
13 - Corner Cap Right	25 x 7 x 48	2.33	4	440	1805
14 - Cap 2 Sided -Face & Back	25 x 7 x 48	2.33	4	440	1805
15 - Cap 3 Sided -Face, Back & End	25 x 7 x 48	2.33	4	440	1805
16 - 48" Taper Top Block	23 x 24 x 48	8	2	1540	3645
17 - 1/2 Top Block	23 x 24 x 24	4	2	1100	2245
18 - Full Corner Top Block Right	27½ x 24 x 52	12	2	2020	4085
19 - Full Corner Top Block Left	27½ x 24 x 52	12	2	2020	4085
20 - Half Corner Top Block Left	23 x 24 x 24	8	2	1240	2525
21 - Half Corner Top Block Right	23 x 24 x 24	8	2	1240	2525
22 - 44" Short Key Top Block	23 x 24 x 44	7.32	2	1400	2845
23 - 52" Long Key Top Block	23 x 24 x 52	8.66	2	2100	4245



Rib Rock Rough Texture



Rib Rock Dry Stack Texture

* The dimensions of all block do not include the face textures. The face textures extend away from the block and will vary from 1-3 inches.

* Cap style is the same for Rough or Dry Stack textures.

Rib Rock™ Landscape Block

Units & Sizes

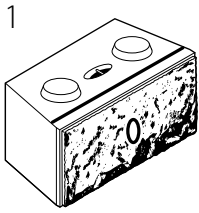

1
6" PVC Drain Block

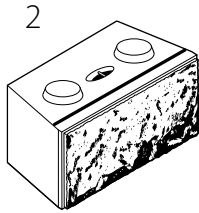

2
Regular Block

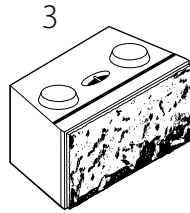

3
44" Short Key Block

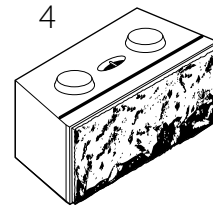

4
52" Long Key Block

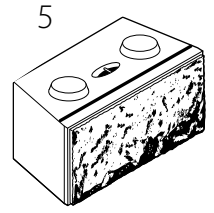

5
Base Block (No Channel)

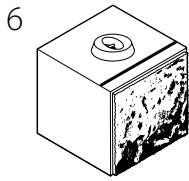

6
Half Block

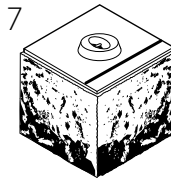

7
Half Corner Block LH

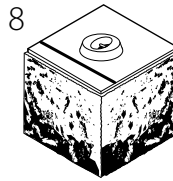

8
Half Corner Block RH

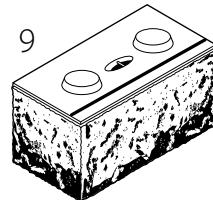

9
Full Corner Block Left

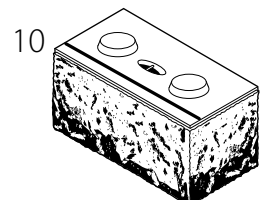

10
Full Corner Block Right

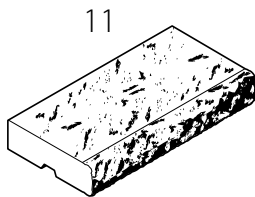

11
Regular Cap

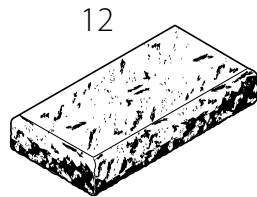

12
Corner Cap Left

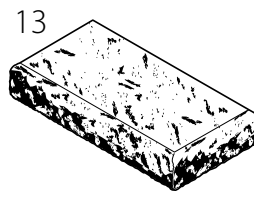

13
Corner Cap Right

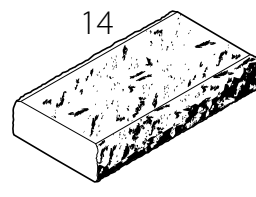

14
Cap - 2 Sided
Face & Back

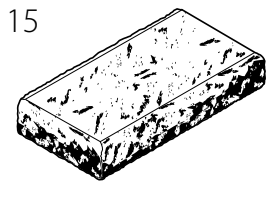

15
Cap - 3 Sided
Face, Back & End

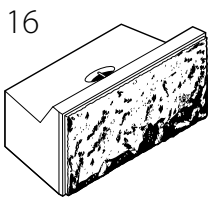

16
48" Taper Top Block

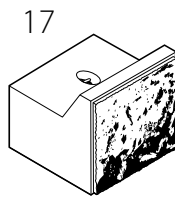

17
1/2 Top Block

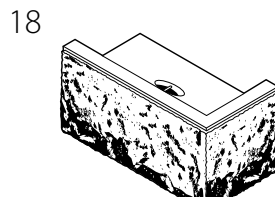

18
Full Corner
Top Block Right

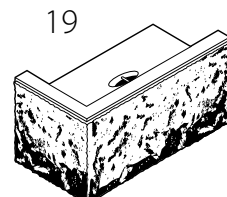

19
Full Corner
Top Block Left

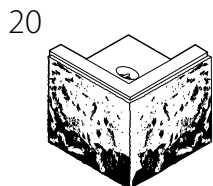

20
Half Corner
Top Block Left

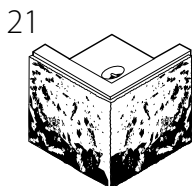

21
Half Corner
Top Block Right

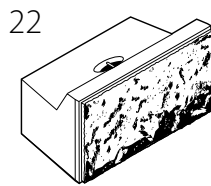

22
44" Short Key
Top Block

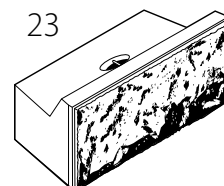

23
52" Long Key
Top Block

Use Top Block to finish off the top of a wall, in place of a cap, if a cap is not required

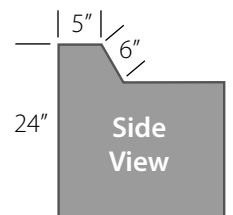

(Dimensions shown are Nominal Sizes)

Rib Rock™ Landscape Block

Installation

Rib Rock Keyblock Installation

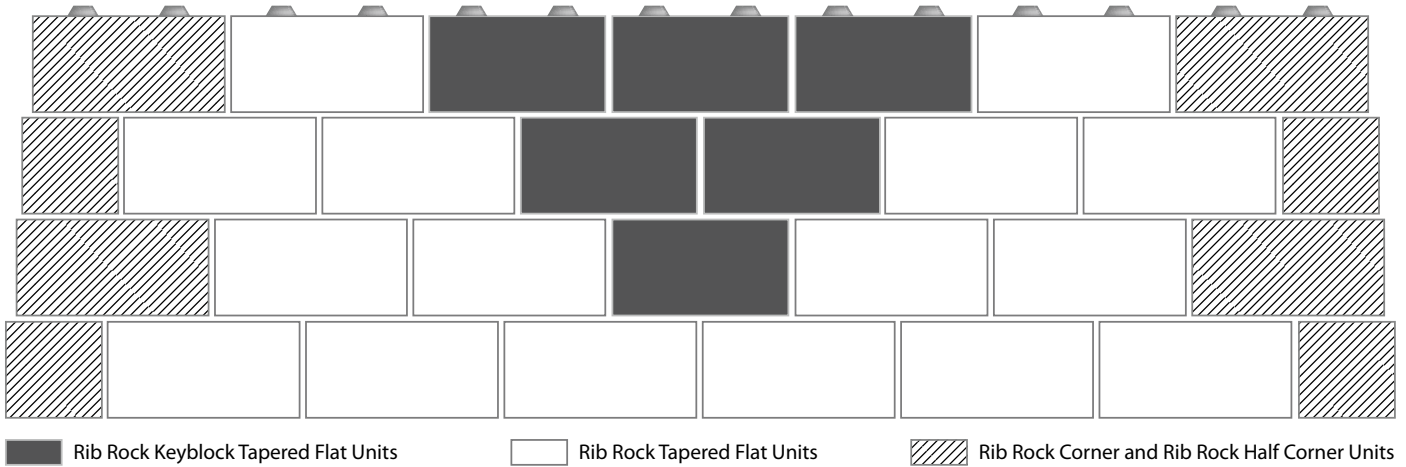

- Short Key Block are used on outside radius and on corners because you gain length due to the 2" set back on every block.
- Long Key Block are used on inside radius because you lose length due to the 2" set back on every block.

8 Foot Wall or Higher (Rib Rock)

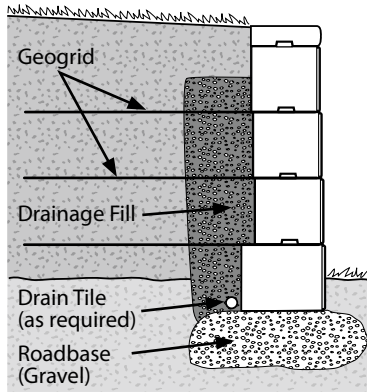

6 Foot Wall (Rib Rock)

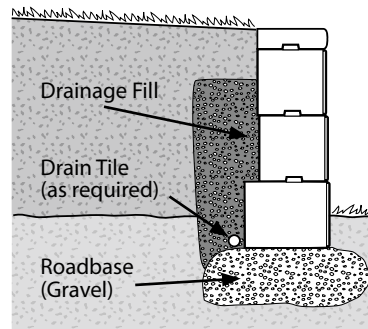

Curves

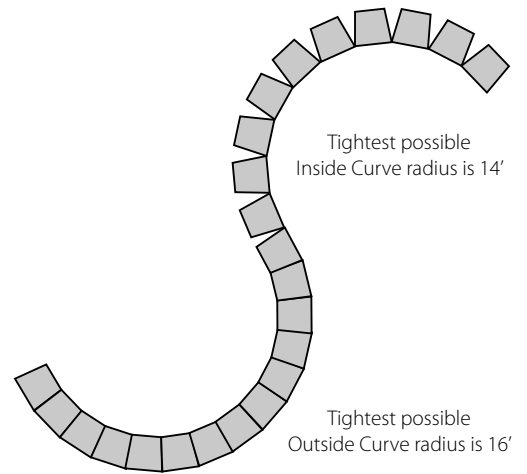

Note: Site conditions may require Geogrid at 6'. Refer to site specific Engineering section

Engineering

Oversize Rib Rock Landscape block can easily make walls up to 6 feet high. For walls over this height, geogrid and site specific engineering will be required. Terracing is another alternative to reach desired wall heights with little or no need for soil reinforcement. Engineering may still be required for local specifications and proper permitting.

Engineering is available for oversize wall projects in the lower 48 states. Call a County Materials' representative at 800-289-2569 for information.

Rib Rock™ Landscape Block



Related Retaining Wall Products

Adhesive

Product	Case Qty.
SRW Adhesive 10.5 oz.	12
SRW Adhesive 29 oz.	12

Landscape Fabric

Product
Mirascap 3' x 300' (per sq yd)
SRW 3' x 50' (per roll)
SRW 3' x 300' (per roll)
SRW 4' x 300' (per roll)
SRW 6' x 300' (per roll)
SRW 12' x 300' (per roll)

Geogrid

Product
SRW 3- 6' x 50' (per roll)
SRW 3- 6' x 150' (per roll)
SRW 3- 12' x 150' (per roll)
SRW 5- 6' x 150' (per roll)
SRW 7- 12' x 150' (per roll)

NEW for 2021!

Universal Wall Caps

Splitface

D x H x L (Nominal Size)
Inches • Millimeters

SF/ Unit	Units/ Pallet	Lbs/ Unit	Lbs/ Pallet
-------------	------------------	--------------	----------------

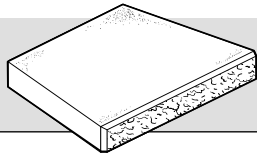

13⁵/₈ x 3 x 18 - 14¹/₄ • 346 x 76 x 457 - 362
Tapered

- 63 50 3195

Notes:

- Splitface on front and back
- Rustic texture products are available in all colors (Made to Order)

Straight Wall Caps

Splitface

D x H x L (Nominal Size)
Inches • Millimeters

SF/ Unit	Units/ Pallet	Lbs/ Unit	Lbs/ Pallet
-------------	------------------	--------------	----------------

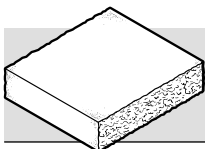

12 x 3⁵/₈ x 15¹/₂ • 305 x 92 x 394
Straight Wall Cap

- 70 54 3805

Notes:

- Splitface on one side
- Rustic texture products are available in all colors (Made to Order)

Related Retaining Wall Products





Outdoor Living Products & Landscape Accessories Specifications



Outdoor Living Products

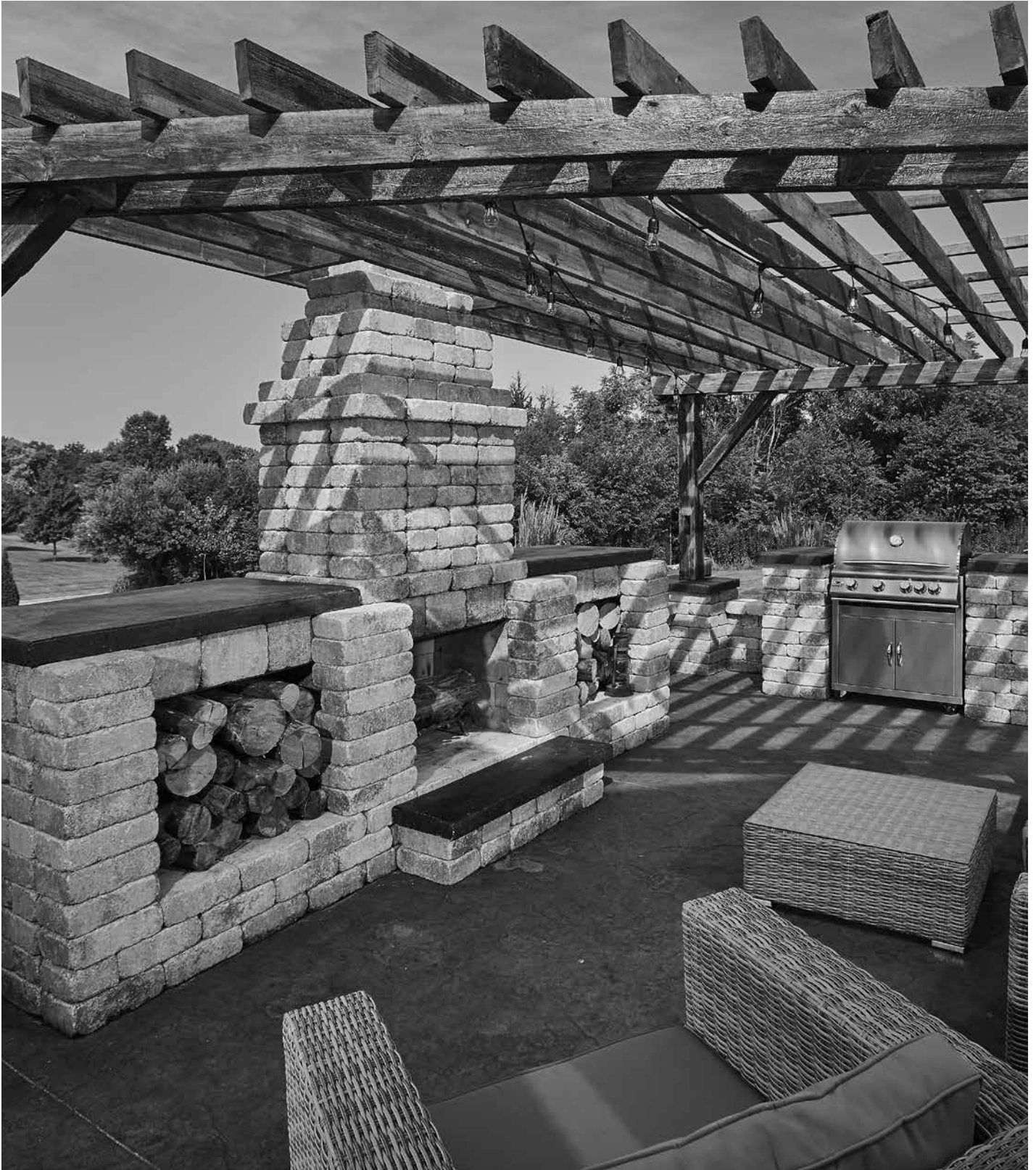

Outdoor Living Product Palletization Table

Palletization Table

Product	How Is This Product Palletized?
Summit Stone® Landscape Units - Medium	Individual sizes palletized separately
Summit Stone® Landscape Units - Large	Individual sizes palletized separately
Summit Stone® Landscape Units - Tapered	Individual sizes palletized separately
Reflection Stone® Full Veneer	9 pc Combo
Reflection Stone® Thin Veneer	9 pc Combo
Reflection Stone® Thin Veneer Corners	8 pc Combo*
Reflection Stone® GRAND Full Veneer	4 pc Combo
Reflection Stone® GRAND Thin Veneer	4 pc Combo
Reflection Stone® GRAND Thin Veneer Corners	3 pc Combo*
Reflection Stone® Brick Full Veneer	4 pc Combo

* Thin Veneer Corners are packaged in a box



Summit Stone® Landscape Units

Units & Sizes

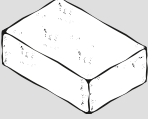
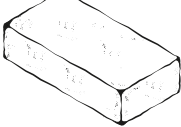
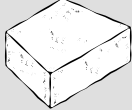
	D x H x L (Nominal Size) Inches • Millimeters	SF/ Unit	Units/ SF	SF/ Layer	Layers/ Pallet	SF/ Pallet	Units/ Layer	Units/ Pallet	Lbs/ Unit	Lbs/ Pallet
Medium 	7¼ x 3⅝ x 10⅞ • 184 x 92 x 276	.27	3.70	5.40	8	43.20	20	160	21	3410
Large 	7¼ x 3⅝ x 14½ • 184 x 92 x 368	.37	2.70	5.55	8	44.40	15	120	28	3410
Tapered 	7¼ x 3⅝ x 9⅞ • 184 x 92 x 251	.27	3.70	6.48	7	45.36	24	168	17.5	2960

Note: Available in Smooth or Tumbled

Layer Configurations

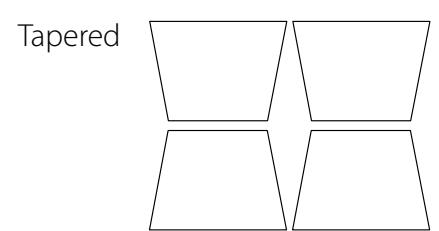
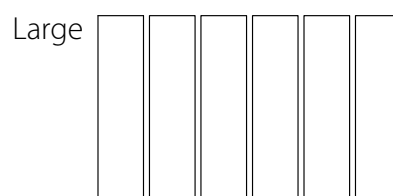
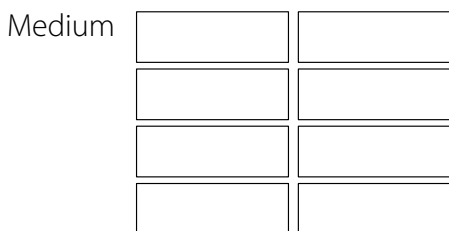

Summit Stone® Landscape Units

Pillar Construction

Decorative Pillars

Summit Stone® is designed to let you build decorative pillars as individual accents or in combination with small decorative walls. No cutting or fitting is required.

To make a pillar with Summit Stone, place units in alternating layers as shown in the illustration below. Make sure you build on level and well compacted ground and recommended base pad. (Ask a Summit Stone dealer for guidelines.)

Apply concrete adhesive between each course as you construct the pillar. Place adhesive on the touching ends and undersides of each cap unit.

The hollow area inside of each pillar can accommodate electrical conduit for a light or a wood 4" x 4" to support a trellis, a lamp post or a garden gate.

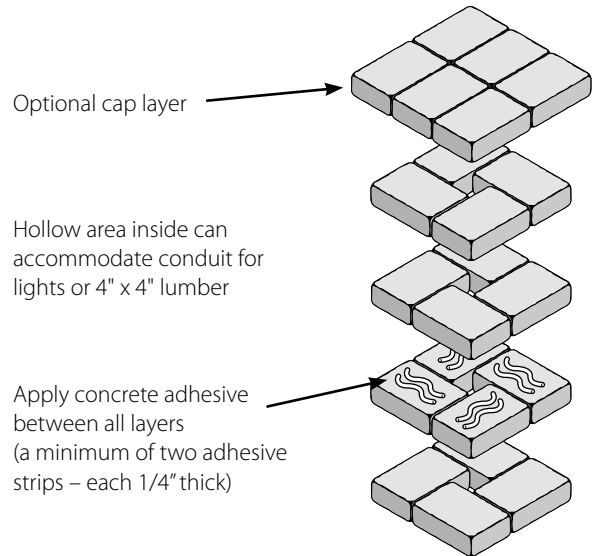

NOTE: Outside measurements of cap layer will be approximately 22"x 22". Post and wall heights should not exceed 36". For decorative walls, columns and steps, 1 to 2 layers of Summit Stone units should be buried below grade for proper embedment.

Pillars with Electrical Conduit

- Sonotube must be placed 4' below grade.
- 24" x 24" x 4" concrete base is joined to the sonotube column with rebar.
- Conduit is placed 12" – 18" below grade (min.).
- Place units in alternating layers as shown below.
- Build on level and well-compacted ground and recommended base pad.
- Apply concrete adhesive between each course.

Medium

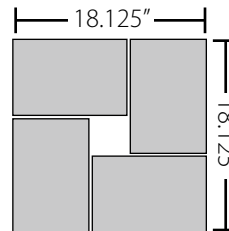

Large

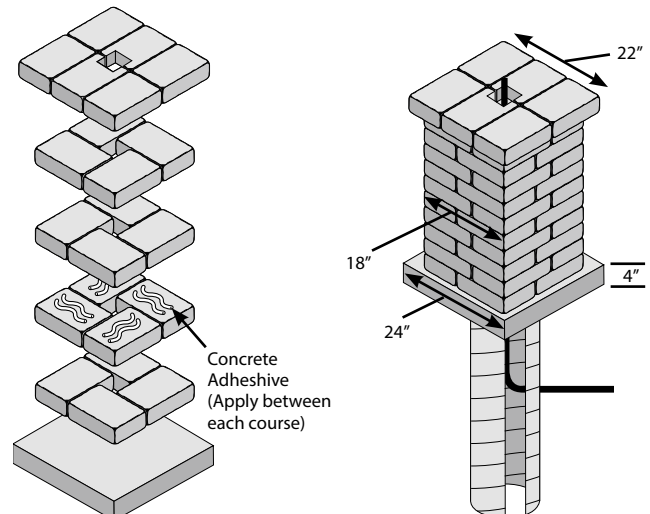
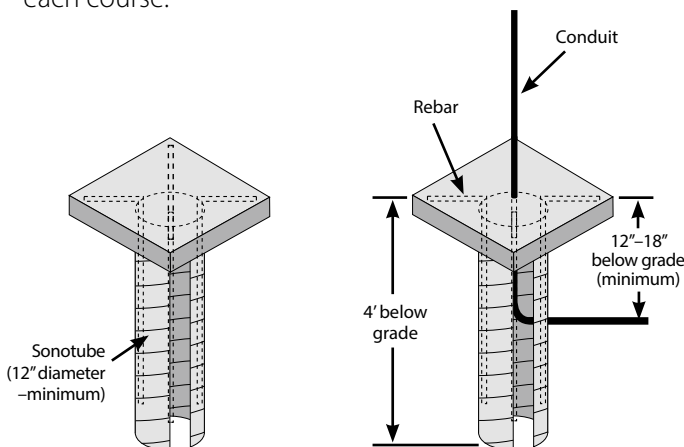
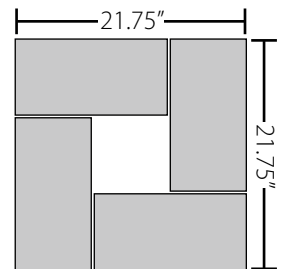

Summit Stone® Landscape Units

Seat Walls, Alcoves and Tables

Seat Wall Patterns

Create Seat Walls that define the boundaries of your outdoor living patio spaces

Seat Walls: Formula for calculating Linear Feet

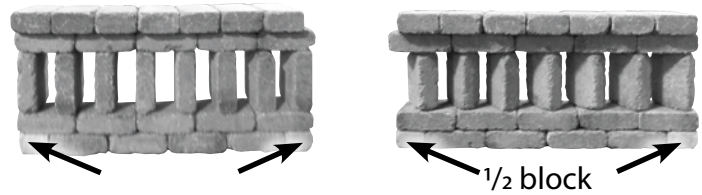

7 block per lineal foot.
Example: A 10-foot wall requires 70 block

Special Features: Surrounds/Alcoves for Grills, Refrigerators, etc.

Enhance Your Outdoor Living Space

Outdoor kitchen appliances can be nestled into covers constructed of Summit Stone Tumbled Landscape Units, giving your outdoor living space an attractive, completed appearance.



Alcove Layout #1

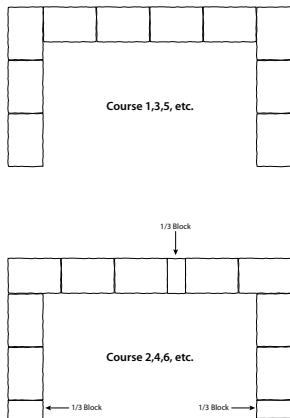

Alcove Layout #2

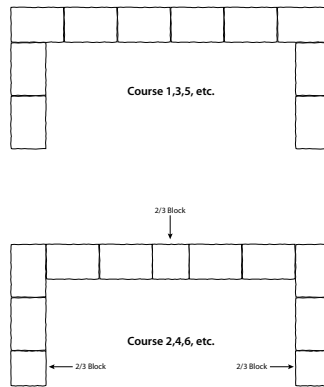

Alcove Layout #3

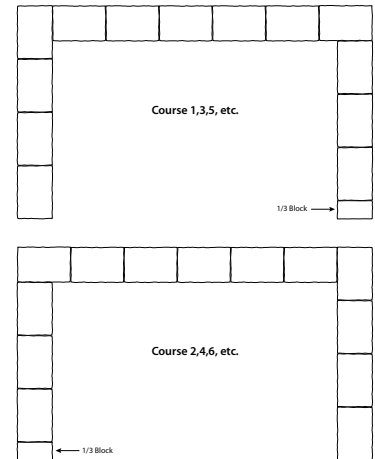

Tables and Counters

Add functionality to your outdoor living space with a Summit Stone constructed table, storage space, bar, etc.



Summit Stone® Landscape Units



Fireplace Kits (Summit Stone®)

Summit Stone Standard Fireplace



Product	Size D x H x L (inches)
Summit Fireplace Standard	54 ³ / ₄ x 79 ³ / ₄ x 84 ¹ / ₄

Standard Fireplace components include:

- (5) - 6" concrete block
 - (5) - 3" soaps
 - (14) - Summit Stone (7¹/₄" x 3⁵/₈" x 10⁷/₈" - Medium) units special cut (1/3 and 2/3)
 - (1) - 10 lbs. pail of Heat Stop II refractory clay
 - (75) - fire brick 2¹/₂" thick
 - (1) - 47" x 3¹/₂" x 3¹/₂" steel lintel
 - (1 left and 1 right) - Summit Stone (7¹/₄" x 3⁵/₈" x 10⁷/₈" - Medium) special cut lintel pad unit
- In addition to the standard fireplace components listed above, 320 Summit Stone (7¹/₄" x 3⁵/₈" x 10⁷/₈" - Medium) are needed to complete project
 - Concrete adhesive is sold separately. Approx. 10-12 tubes of adhesive will be required, depending on the quantity applied to each Summit Stone

Approx. 8000 lbs. - 3 total pallets

Summit Stone Double Woodbox Fireplace



Product	Size D x H x L (inches)
Summit Fireplace Double Woodbox	54 x 79 ³ / ₄ x 141 ³ / ₈

Double Woodbox Fireplace components include:

- (5) - 6" concrete block
 - (16) - 4" concrete block
 - (5) - 3" soaps
 - (18) - Summit Stone (7¹/₄" x 3⁵/₈" x 10⁷/₈" - Medium) units special cut (1/3 and 2/3)
 - (1) - 10 lbs. pail of Heat Stop II refractory clay
 - (75) - fire brick 2¹/₂" thick
 - (1) - 47" x 3¹/₂" x 3¹/₂" steel lintel
 - (2) - 42" x 3¹/₂" x 3¹/₂" steel lintels
 - (1 left and 1 right) - Summit Stone (7¹/₄" x 3⁵/₈" x 10⁷/₈" - Medium) special cut lintel pad unit
 - (2) - Summit Stone (7¹/₄" x 3⁵/₈" x 10⁷/₈" - Medium) units special cut common grooved lintel pad
- In addition to the double woodbox fireplace components listed above, 500 Summit Stone (7¹/₄" x 3⁵/₈" x 10⁷/₈" - Medium) are needed to complete project
 - Concrete adhesive is sold separately. Approx. 10-12 tubes of adhesive will be required, depending on the quantity applied to each Summit Stone
 - Grate is not sold with the kit

Approx. 12,000 lbs. - 5 total pallets

Disclaimer: This is a basic outdoor fireplace kit design. Outdoor fireplaces should always be constructed by a knowledgeable professional. Location, chimney height, flue size and prevailing winds can affect the performance of an outdoor fireplace. County Materials cannot guarantee the performance or structural integrity of this fireplace. Use only industry accepted materials, cements and adhesives when constructing an outdoor fireplace. Always observe building codes and local bylaws.

Fireplace Kits and Fire Pit Products (Summit Stone®)

Summit Stone Corner Fireplace



Product	Size D x H x L (inches)
Summit Fireplace Corner	82 x 79 ³ / ₄ x 104

Corner Fireplace components include:

- (20) - 8" 1/4 concrete block
 - (5) - 6" concrete block
 - (20) - 4" concrete block
 - (5) - 3" soaps
 - (54) - Summit Stone (7 1/4" x 3 5/8" x 10 7/8" - Medium) units special cut (1/3 and 2/3)
 - (1) - 10 lbs. pail of Heat Stop II refractory clay
 - (75) - fire brick 2 1/2" thick
 - (1) - 47" x 3 1/2" x 3 1/2" steel lintel
 - (1 left and 1 right) - Summit Stone (7 1/4" x 3 5/8" x 10 7/8" - Medium) special cut lintel pad unit
 - (2) - Summit Stone (7 1/4" x 3 5/8" x 10 7/8" - Medium) units special cut common grooved lintel pad
- In addition to the corner fireplace components listed above, 420 Summit Stone (7 1/4" x 3 5/8" x 10 7/8" - Medium) are needed to complete project
 - Concrete adhesive is sold separately. Approx. 10-12 tubes of adhesive will be required, depending on the quantity applied to each Summit Stone

Approx. 10,320 lbs. - 4 total pallets

Summit Stone Circular Fire Pit Design

The Summit Stone Tapered Unit can be used to design circular or square Fire Pits and Serpentine Walls. The Tapered Unit is available in 4 colors (Haven, Hush, Solace and Timeless) and sold by the unit.



39" Circle Fire Pit Kit Includes:

- 39" x 11" Metal Fire Ring (Rolled Steel – no paint)
- 51 Summit Stone (Tapered) Landscape Units
- Available in either Smooth or Tumbled Texture
- Available in the following Summit Stone Colors – Timeless, Hush, Solace, Vision, Reflection, Haven and Majestic

Fire Ring Cap (4 sections)

NEW for 2021!



Fire Ring Cap (4 pieces assembled)
(Nominal Size) • Inches

Inside Diameter – 39
Outside Diameter – 57
Height – 2 3/4

Summit Stone 3' High Serpentine Wall Design



Reflection Stone® Masonry Units - Full Veneer

Units & Sizes

H x D x L (Nominal Size)
Inches • Millimeters

R1  3¼ x 3¾ x 3¼ • 83 x 95 x 83

R2  3¼ x 3¾ x 7 • 83 x 95 x 178

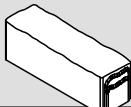
R3  3¼ x 3¾ x 10¾ • 83 x 95 x 273

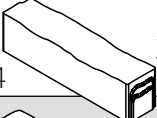
R4  3¼ x 3¾ x 14½ • 83 x 95 x 369

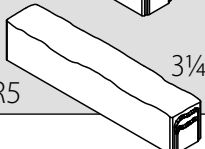
R5  3¼ x 3¾ x 18¼ • 83 x 95 x 464

H x D x L (Nominal Size)
Inches • Millimeters

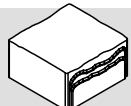
R6  7 x 3¾ x 7 • 178 x 95 x 178

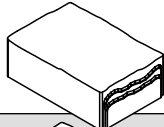
R7  7 x 3¾ x 10¾ • 178 x 95 x 273

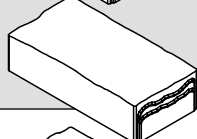
R8  7 x 3¾ x 14½ • 178 x 95 x 369

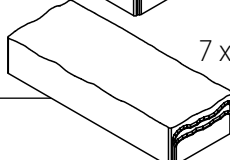
R9  7 x 3¾ x 18¼ • 178 x 95 x 464

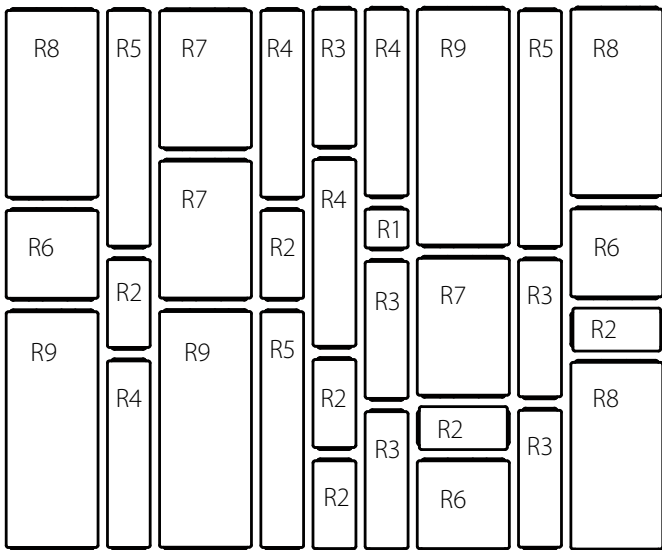

SF/Layer	SF/Pallet	Lbs./Pallet
13.50	81	3280

Layer Configuration



Reflection Stone® Masonry Units - Thin Veneer

Units & Sizes

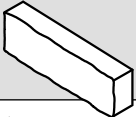
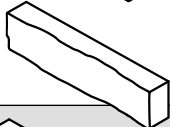
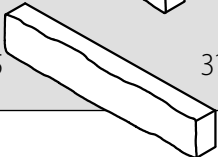
Faces	H x D x L (Nominal Size) Inches • Millimeters
RTV1 	3¼ x 1 x 3¼ • 83 x 25 x 83
RTV2 	3¼ x 1 x 7 • 83 x 25 x 178
RTV3 	3¼ x 1 x 10¾ • 83 x 25 x 273
RTV4 	3¼ x 1 x 14½ • 83 x 25 x 369
RTV5 	3¼ x 1 x 18¼ • 83 x 25 x 464

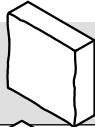
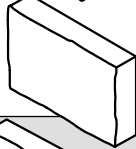
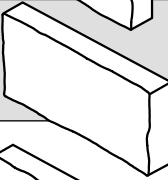
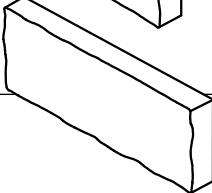
	H x D x L (Nominal Size) Inches • Millimeters
RTV6 	7 x 1 x 7 • 178 x 25 x 178
RTV7 	7 x 1 x 10¾ • 178 x 25 x 273
RTV8 	7 x 1 x 14½ • 178 x 25 x 369
RTV9 	7 x 1 x 18¼ • 178 x 25 x 464

SF/Layer	Layers/Pallet	SF/Pallet	Lbs/Pallet
13.5	10	135	1474

* Reflection Stone thin veneer thickness will range from 3/4" to 1 1/4"

Units & Sizes

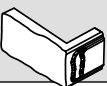
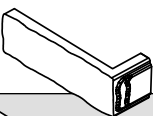
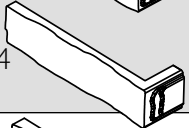
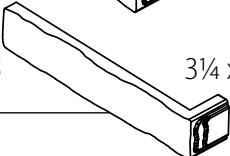
Corners	H x D x L (Nominal Size) Inches • Millimeters
RTVC2 	3¼ x 1 x 7 • 83 x 25 x 178
RTVC3 	3¼ x 1 x 10¾ • 83 x 25 x 273
RTVC4 	3¼ x 1 x 14½ • 83 x 25 x 369
RTVC5 	3¼ x 1 x 18¼ • 83 x 25 x 464

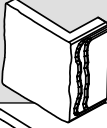
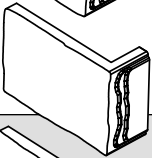
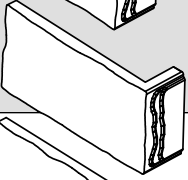
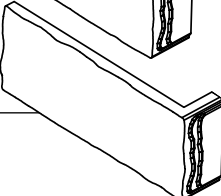
	H x D x L (Nominal Size) Inches • Millimeters
RTVC6 	7 x 1 x 7 • 178 x 25 x 178
RTVC7 	7 x 1 x 10¾ • 178 x 25 x 273
RTVC8 	7 x 1 x 14½ • 178 x 25 x 369
RTVC9 	7 x 1 x 18¼ • 178 x 25 x 464

LF/Box	SF/Box	Lbs./Box
4.57	6.22	59

• Reflection Stone thin veneer thickness will range from 3/4" to 1 1/4"

• All Return Ends are 3 3/4" in depth

Reflection Stone® GRAND Masonry Units - Full & Thin Veneer

Units & Sizes - Full Veneer

H x D x L (Nominal Size)
Inches • Millimeters

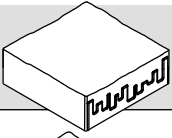
RG1  $10\frac{3}{4} \times 3\frac{3}{4} \times 10\frac{3}{4}$ • 273 x 95 x 273

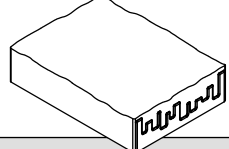
RG2  $10\frac{3}{4} \times 3\frac{3}{4} \times 14\frac{11}{16}$ • 273 x 95 x 373

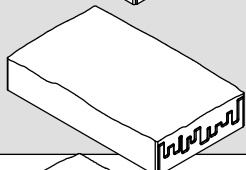
RG3  $10\frac{3}{4} \times 3\frac{3}{4} \times 18\frac{7}{16}$ • 273 x 95 x 468

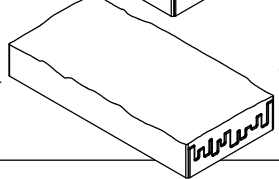
RG4  $10\frac{3}{4} \times 3\frac{3}{4} \times 22\frac{3}{16}$ • 273 x 95 x 563

Layer Configuration

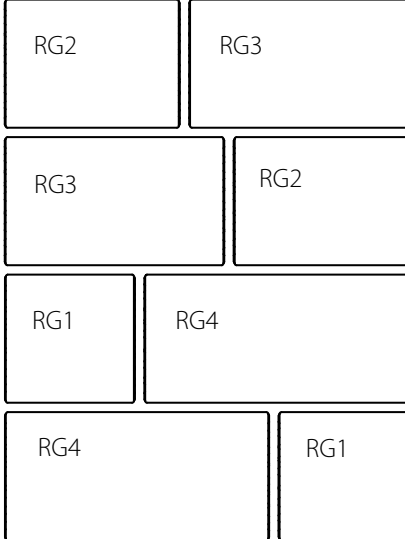

SF/Layer	SF/Pallet	Lbs./Pallet
11	66	2617

Units & Sizes - Thin Veneer

Faces

H x D x L (Nominal Size)
Inches • Millimeters

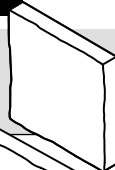
RGTV1  $10\frac{3}{4} \times 1 \times 10\frac{3}{4}$ • 273 x 25 x 273

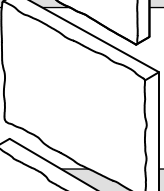
RGTV2  $10\frac{3}{4} \times 1 \times 14\frac{11}{16}$ • 273 x 25 x 373

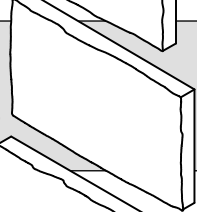
RGTV3  $10\frac{3}{4} \times 1 \times 18\frac{7}{16}$ • 273 x 25 x 468

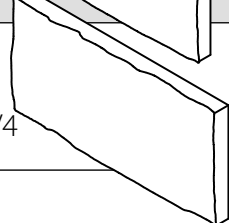
RGTV4  $10\frac{3}{4} \times 1 \times 22\frac{3}{16}$ • 273 x 25 x 563

SF/Layer	Layers/Pallet	SF/Pallet	Lbs./Pallet
11	10	110	1412

Corners

H x D x L (Nominal Size)
Inches • Millimeters

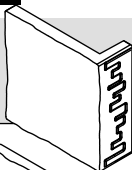
RGTV1C1  $10\frac{3}{4} \times 1 \times 10\frac{3}{4}$ • 273 x 25 x 273

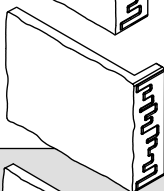
RGTV2C2  $10\frac{3}{4} \times 1 \times 14\frac{11}{16}$ • 273 x 25 x 373

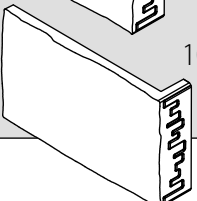
RGTV3C3  $10\frac{3}{4} \times 1 \times 18\frac{7}{16}$ • 273 x 25 x 468

- Reflection Stone GRAND and Brick thin veneer thickness will range from 3/4" to 1 1/4"
- All Return Ends are 3 3/4" in depth

LF/Box	SF/Box	Lbs./Box
5.53	8.69	90

Reflection Stone® Brick Masonry Units - Full Veneer

Units & Sizes - Full Veneer

H x D x L (Nominal Size)
Inches • Millimeters

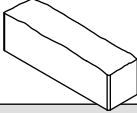
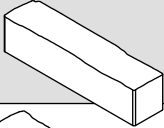
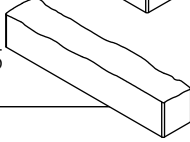
RB2		3¼ x 3¾ x 7 • 83 x 95 x 178						
RB3		3¼ x 3¾ x 10¾ • 83 x 95 x 273						
RB4		3¼ x 3¾ x 14½ • 83 x 95 x 369						
RB5		3¼ x 3¾ x 18¼ • 83 x 95 x 464						
<table border="1"> <thead> <tr> <th>SF/Layer</th> <th>SF/Pallet</th> <th>Lbs./Pallet</th> </tr> </thead> <tbody> <tr> <td>13.3</td> <td>80</td> <td>2940</td> </tr> </tbody> </table>		SF/Layer	SF/Pallet	Lbs./Pallet	13.3	80	2940	
SF/Layer	SF/Pallet	Lbs./Pallet						
13.3	80	2940						

Layer Configuration

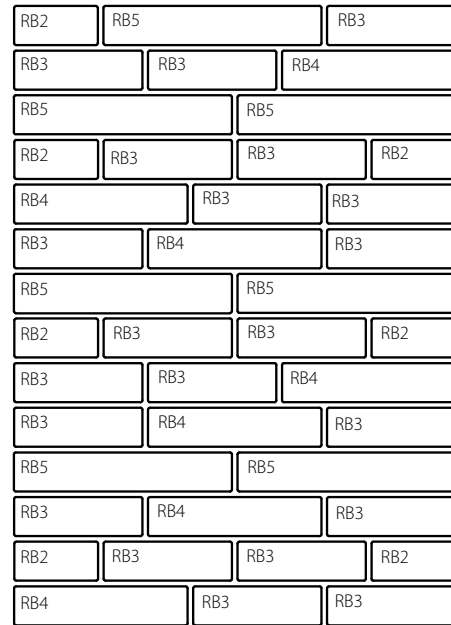



Landscape Accessories



Passageways® Step Units

Units & Sizes

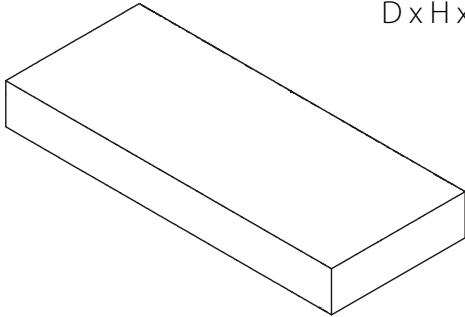

D x H x L (Nominal Size)
Inches

20 x 6 x 48

Units/ Pallet	Lbs./ Unit	Lbs./ Pallet
4	430	1850

Note: Textured face on both sides of the step.



Landscape Step Units

Units & Sizes

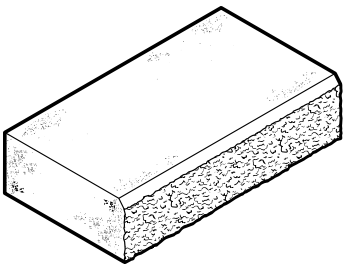

D x H x L (Nominal Size)
Inches

14 x 6 x 24

Units/ Pallet	Lbs./ Unit	Lbs./ Pallet
10	164	1680



Oversize Landscape Step Units

Units & Sizes

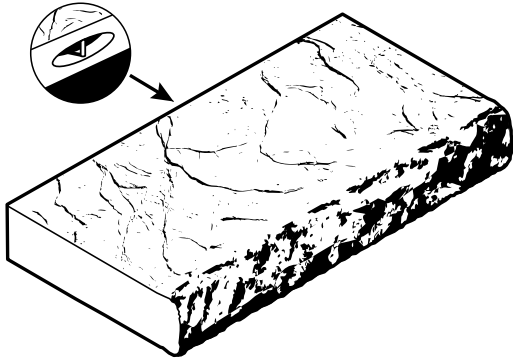

D x H x L (Nominal Size)
Inches

25 x 6¼ x 48

Units/ Pallet	Lbs./ Unit	Lbs./ Pallet
4	760	3085



Crest™ Bullnose Pavers

Units & Sizes

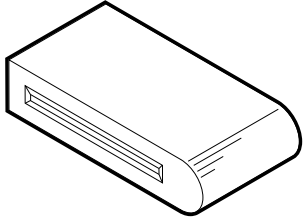

D x H x L (Nominal Size)
Inches • Millimeters

6 x 2¾ x 12 • 152 x 70 x 305

SF/Unit	Units/SF	Lbs./Unit	Units/Cube	Lbs./Cube
.5	2	15.36	280	4350



NEW for 2021!

Finishing Touches

Column and Seat Wall Caps

(Available in REFLECTION and VISION colors ONLY)



Note: Seat Wall Caps can also be used for coping and step treads.

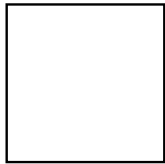

Column Caps
D x H x L
(Nominal Size) • Inches
24 x 2 3/4 x 24



Seat Wall Caps
D x H x L
(Nominal Size) • Inches
13 7/8 x 2 3/4 x 29 3/4

Burnished Wall Accents

(Available in GALAXY and SEA SALT colors ONLY)

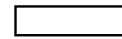
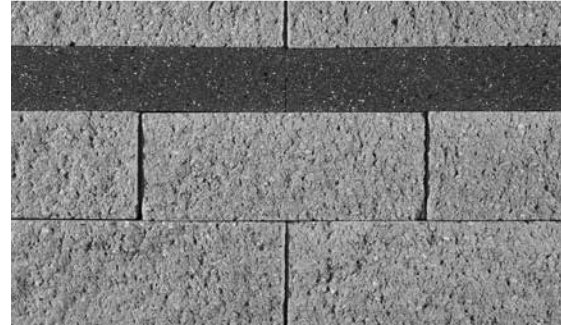

D x H x L
(Nominal Size) • Inches
4 x 4 x 16

SF/ Unit	Units/ SF	SF/ Layer	Layers/ Pallet	SF/ Pallet	Units/ Layer	Units/ Pallet	Lbs./ Pallet
.39	2.56	11.7	5	58.5	30	150	2500

Fire Ring Cap (4 sections)

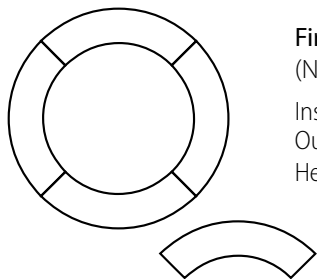

Fire Ring Cap (4 pieces assembled)
(Nominal Size) • Inches
Inside Diameter – 39
Outside Diameter – 57
Height – 2 3/4

Note: Our cast stone products (Fire Ring Cap, Column Cap, Seat Wall Cap and Passageways Step Units) all have matching face textures.

Alliance Outdoor Lighting

Bring your landscape investment to life (after hours) – with high-quality, option-packed **Alliance Outdoor Lighting** products...

- Low Voltage Light Paths
- Ground Lights
- Bullet Lights
- Post Lights
- Wall Lights
- Sconces
- RGB Color Changing and Dimming options with Blue Tooth (BT) Technology
- And Much More...



Please contact one of our locations or your local representative to plan your lighting project.

Locations

Appleton

3019 W Prospect Ave.
Appleton, WI 54914
920-734-7733

Holmen

611 Empire St.
Holmen, WI 54636
608-526-9020

Oak Creek

7200 S 10th St.
Oak Creek, WI 53154
414-764-8700

Tomahawk

407 S Tomahawk Ave.
Tomahawk, WI 54487
715-453-5463

Eau Claire

1211 Menomonie St.
Eau Claire, WI 54703
715-834-7701

Madison

6399 Nesbitt Rd.
Madison, WI 53719
608-845-8636

Rice Lake

3200 S Main St.
Rice Lake, WI 54868
715-234-8145

Weston

9303 Schofield Ave.
Weston, WI 54476
715-359-7731

Green Bay

2448 Century Rd.
Green Bay, WI 54303
920-497-2416

Marathon

205 North St.
Marathon, WI 54448
715-848-1365

Roberts

1203 70th Ave.
Roberts, WI 54023
715-749-4121

Wisconsin Rapids

2310 N 40th St.
Wisconsin Rapids, WI 54494
715-423-7339

Hazelhurst

6857 US Hwy 51
Hazelhurst, WI 54531
715-356-1174

Milwaukee/Butler

5000 North 124th Street
Milwaukee, WI 53225
262-896-0755

Stevens Point

2000 Patch St.
Stevens Point, WI 54481
715-341-0991

Contact Customer Service at (800) 242-7733 or visit our website at www.countymaterials.com for additional information about County Materials' Dealer Locations.



*Proud to be American based
and American made since 1946*

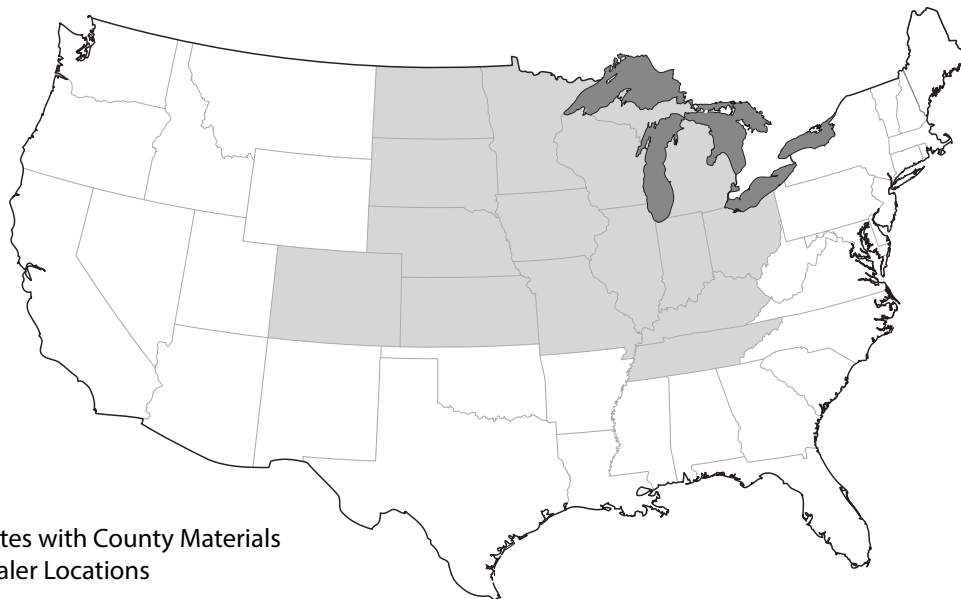

We value your business. Please contact your County Materials' representative for specific information on products and their availability in your area.







(800) 242-7733
countymaterials.com
info@countymaterials.com

©2021 County Materials Corporation
621418450_0521